

Urban
elementz.

Innovative Designs for Quilters and Crafters

Featuring Butterfly - Purple Dotz - Applique



Design Board Catalog

Winter 2026

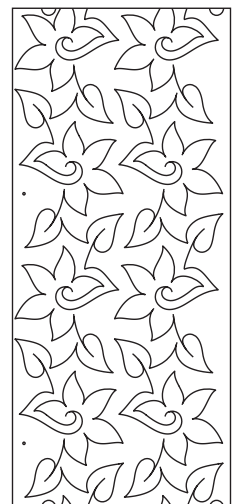

Bellflower
Design Board

© Patricia E. Ritter



Design Boards

*Design boards are made of a strong, light-weight PVC like material with nonskid backing.
Multiple boards can be connected end-to-end to make longer boards.
Connectors are supplied when ordering multiple quantities of the same design.
These design boards are made to be used with a stylus.*

Design board sets include two of the same design boards to create a larger overall design.
The set size listed is the total size of these two boards together.

Additional information and pricing can be found at:
www.urbanelementz.com



To see our entire selection of:

Pantographs
Tear Away
Stencils
Design Boards
Appliqué Elementz
Tattoo Elementz - Decorative Decals
Patterns and Books
Quilting Accessories

Visit our website at:

www.urbanelementz.com

1308 common street
suite 205 . box 50
new braunfels . texas . 78130
830 . 964 . 6133

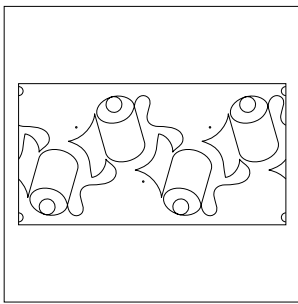

2-Ply
Design Size - 10" x 22.25"
© Melonie J. Caldwell

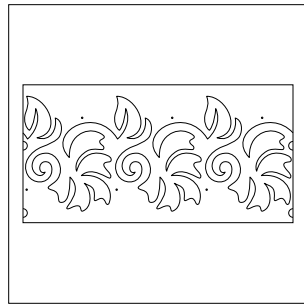

A Little Bit This
Design Size - 10" x 23.5"
© Barbara Becker

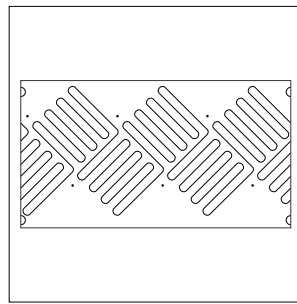

Abacus
Design Size - 10.5" x 22"
© Patricia E. Ritter & Tracey Russell

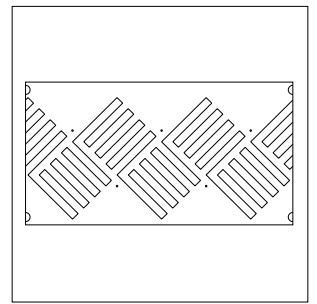

Abacus - Squared
Design Size - 10" x 22"
© Patricia E. Ritter & Tracey Russell

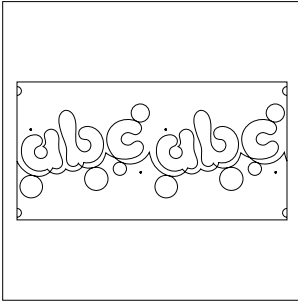

ABC Bubbles
Design Size - 8" x 23"
© Naomi Hynes

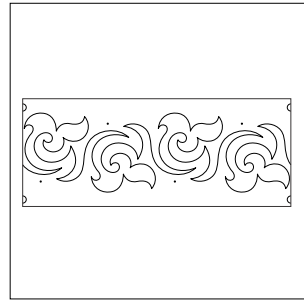

Abigail
Design Size - 8.25" x 28"
© Sarah Ann Myers

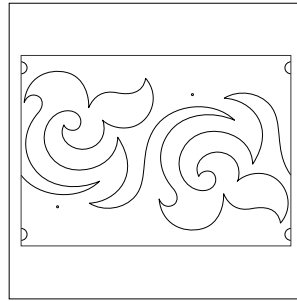

Abigail - Grande - Set
Set Size - 10" x 34"
© Sarah Ann Myers

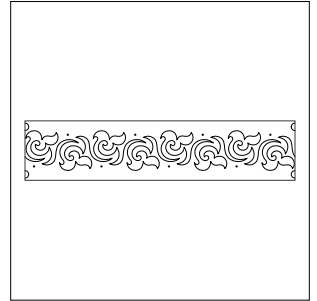

Abigail - Petite
Design Size - 4" x 27.25"
© Sarah Ann Myers

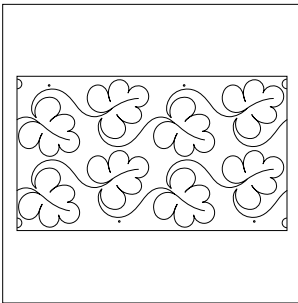

Abundant Leaves
Single Row Size - 6" x 21"
© Hermione Agee

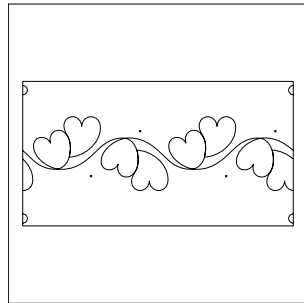

Adorable
Design Size - 6" x 22"
© Hermione Agee

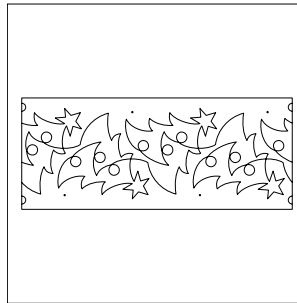

Advent
Design Size - 8.5" x 25.5"
© Hermione Agee

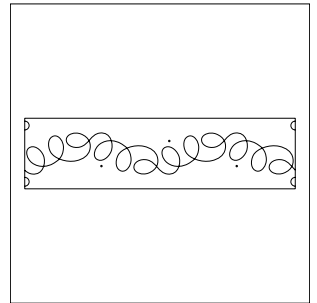

Aerial
Design Size - 3.5" x 23"
© Melonie J. Caldwell

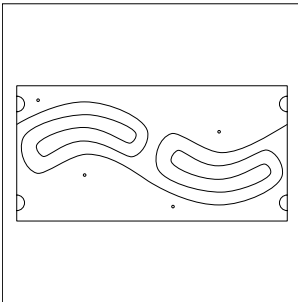

African Heat Wave - Set
Set Size - 5" x 26"
© Apricot Moon Designs

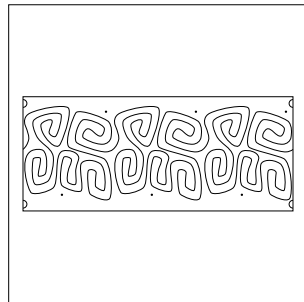

African Samba
Design Size - 9" x 26"
© Apricot Moon Designs

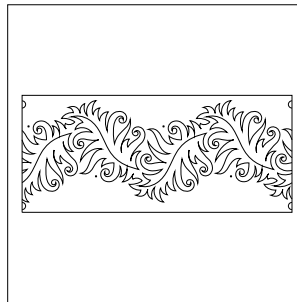

Agave
Design Size - 10.5" x 28"
© Patricia E. Ritter

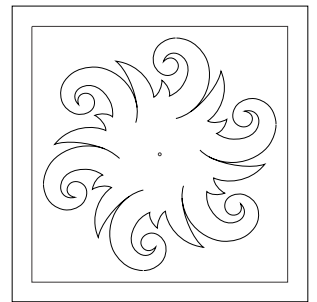

Agave - Block #1
Design Size - 10" x 10"
© Patricia E. Ritter



Agave - Block #2
Design Size - 10" x 10"
© Patricia E. Ritter

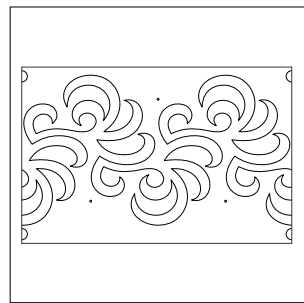

Airborne - Set
Set Size - 10" x 36"
© Barbara Becker

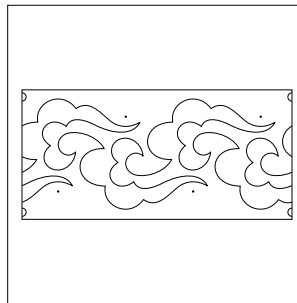

Airy
Design Size - 10" x 24.5"
© Hermione Agee

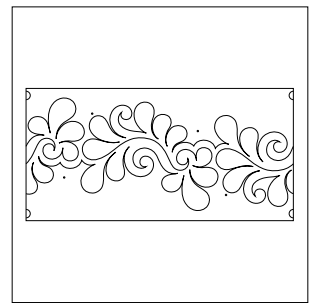

Ajouré
Design Size - 10" x 23.75"
© Patricia E. Ritter

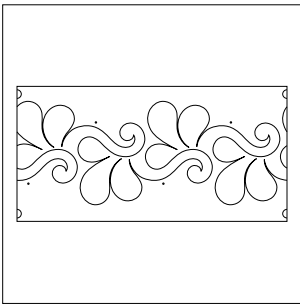

Ajouré - Petite
Design Size - 9" x 23.5"
© Patricia E. Ritter

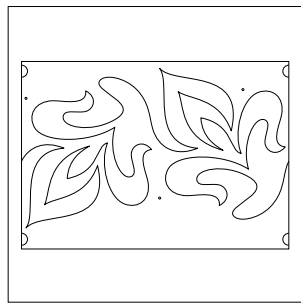

Aladdin - Set
Set Size - 10" x 33.5"
© Hermione Agee

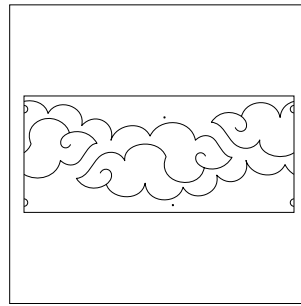

Albion
Design Size - 10" x 27.25"
© Hermione Agee

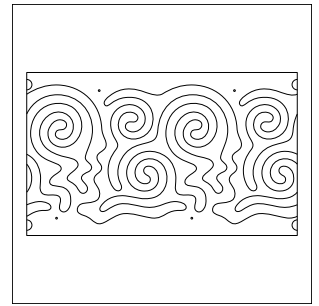

Alcazar
Design Size - 10" x 19.5"
© Patricia E. Ritter

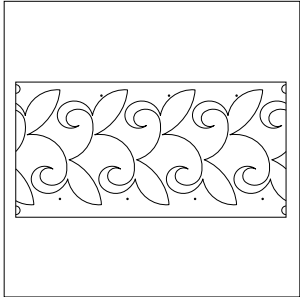

Alex
Design Size - 10" x 23.5"
© Keryn Emmerson

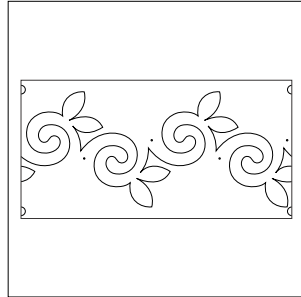

Alfalfa
Design Size - 10" x 23.5"
© Sarah Ann Myers

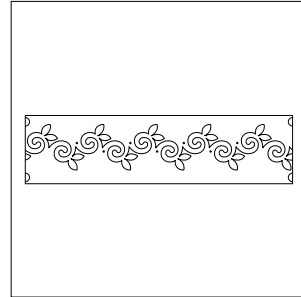

Alfalfa - Petite
Design Size - 4" x 23.5"
© Sarah Ann Myers

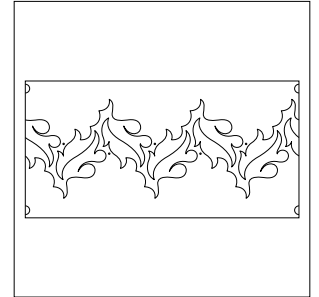

Alight
Design Size - 8.5" x 23.5"
© Hermione Agee

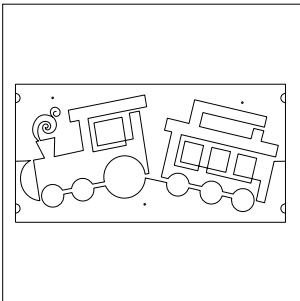

All Aboard
Design Size - 9.5" x 22"
© Patricia E. Ritter

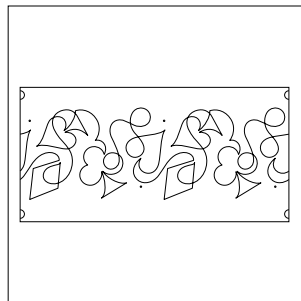

All Decked Out
Design Size - 8" x 23.5"
© Jessica Schick

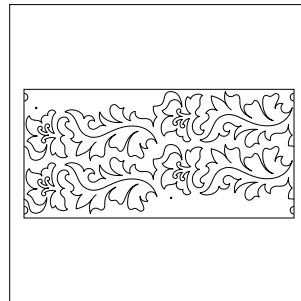

Aloha
Single Row Size - 7" x 26.75"
© Patricia E. Ritter

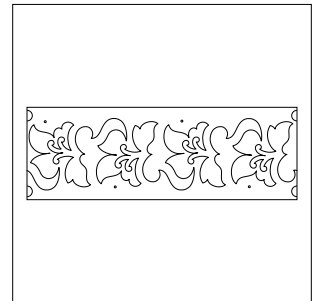

Aloha - Petite
Design Size - 5" x 19"
© Patricia E. Ritter

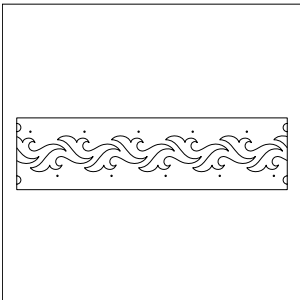

Aloha - Sashing
Design Size - 3.25" x 24.5"
© Patricia E. Ritter

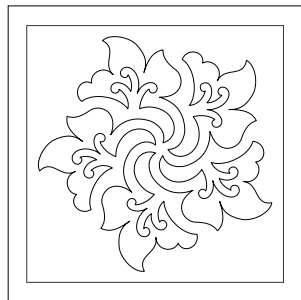

Aloha - Block #1
Design Size - 10" x 10"
© Patricia E. Ritter

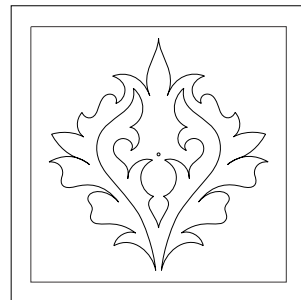

Aloha - Block #2
Design Size - 9.5" x 10"
© Patricia E. Ritter

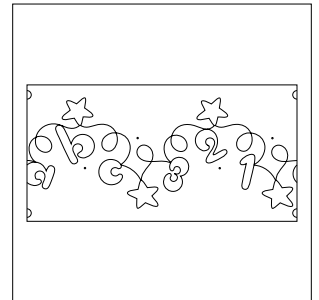

Alphabet Soup #3
Design Size - 9.75" x 23.75"
© Patricia E. Ritter

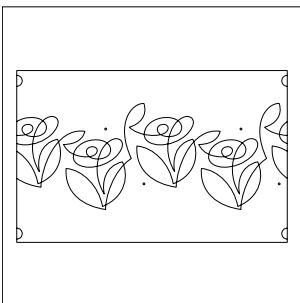

Alpine Meadow
Design Size - 7.25" x 18.5"
© Hermione Agee

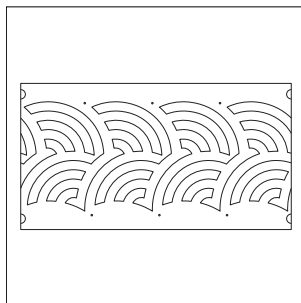

Alternating Baptist Fan
Design Size - 8.75" x 21.75"
© Jessica Schick

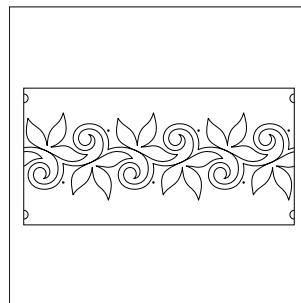

Always Ivy
Design Size - 7.5" x 23.25"
© Apricot Moon Designs

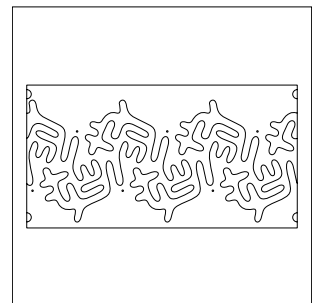

Amaze Me
Design Size - 10" x 22.25"
© Barbara Becker

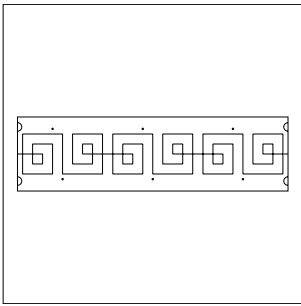

Amazed
Design Size - 3.5" x 23.75"

© Lakeridge Designs / Kimberly Dewling

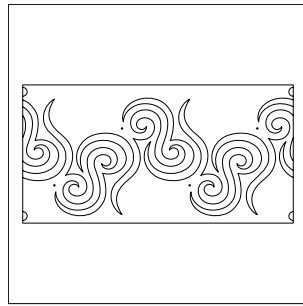

Amber
Design Size - 10" x 23"

© Sarah Ann Myers

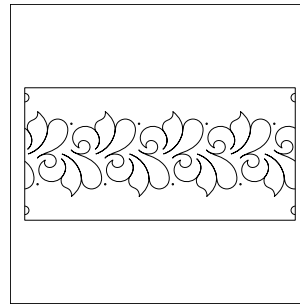

Ambrosia
Design Size - 7.5" x 24"

© Hermione Agee

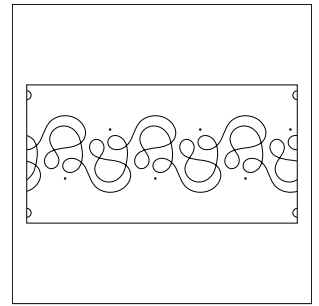

Ampersand
Design Size - 6.5" x 23"

© Patricia E. Ritter & Sarah Ann Myers

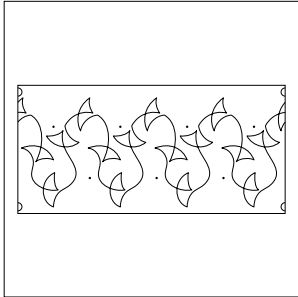

Amphibian
Design Size - 10" x 24.5"

© Hermione Agee

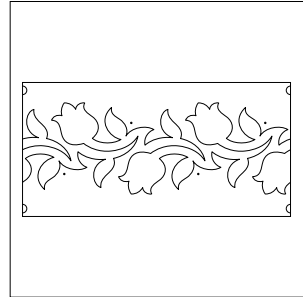

Amsterdam
Design Size - 8" x 23.5"

© Hermione Agee

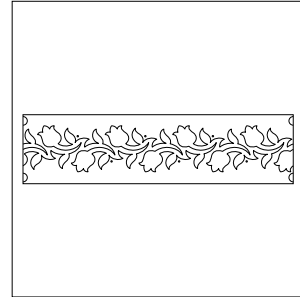

Amsterdam - Petite
Design Size - 4" x 23.5"

© Hermione Agee

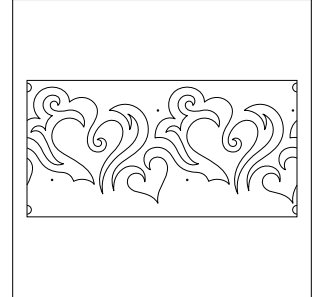

Amulet
Design Size - 10" x 23.25"

© Hermione Agee

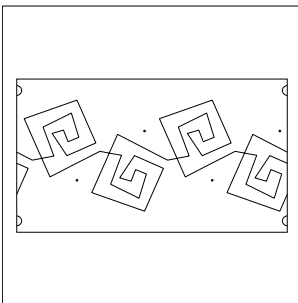

Amusement
Design Size - 8.5" x 20.75"

© Sarah Ann Myers

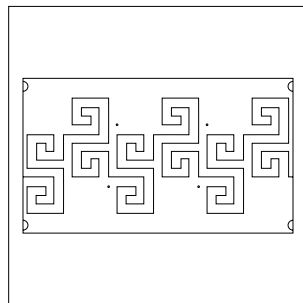

Analog
Design Size - 8.75" x 20.5"

© Sarah Ann Myers

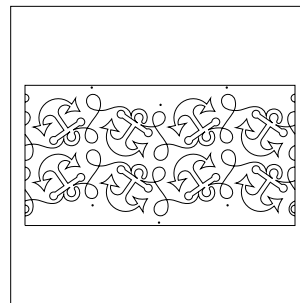

Anchors Away
Single Row Size - 6.5" x 26"

© Patricia E. Ritter

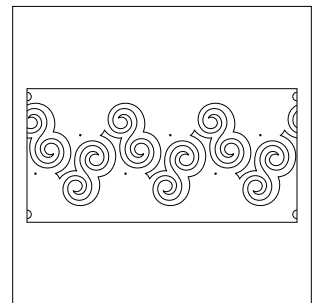

Ancient Scrolls
Design Size - 9" x 23.75"

© Patricia E. Ritter

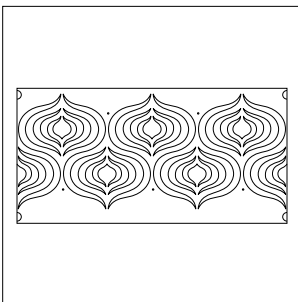

Andalusia
Design Size - 10" x 23.5"

© Patricia E. Ritter

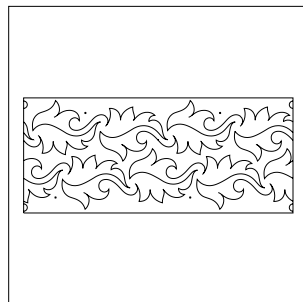

Angel Wing Begonia
Single Row Size - 6.25" x 27.5"

© Patricia E. Ritter

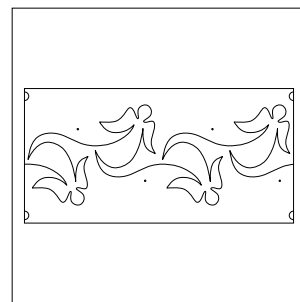

Angel Wings
Design Size - 8.75" x 23.5"

© Apricot Moon Designs

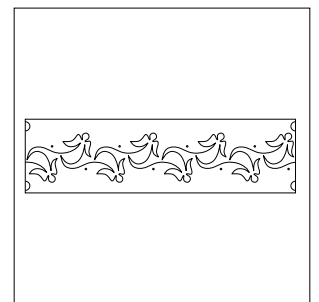

Angel Wings - Petite
Design Size - 4" x 22"

© Apricot Moon Designs

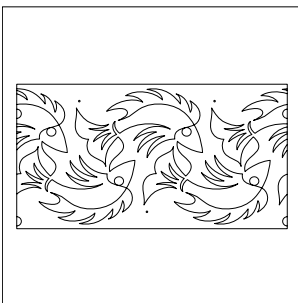

Angler
Design Size - 11" x 22"

© Hermione Agee

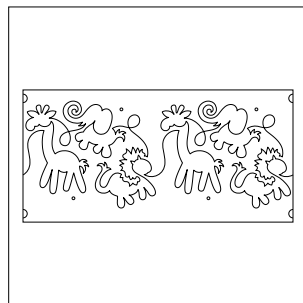

Animal Crackers
Design Size - 9.5" x 24"

© Patricia E. Ritter

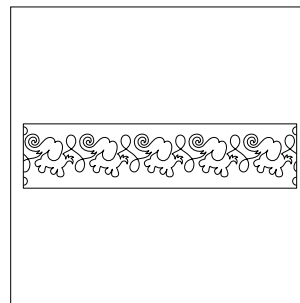

Animal Crackers - Elephants - Bdr
Design Size - 4" x 25.5"

© Patricia E. Ritter

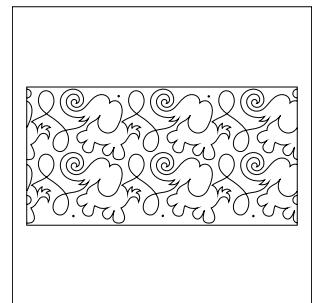

Animal Crackers - Elephants - Bdr
Single Row Size - 6" x 23"

© Patricia E. Ritter

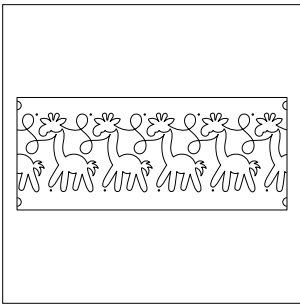

Animal Crackers - Giraffes - Bar
Design Size - 7" x 24"
© Patricia E. Ritter

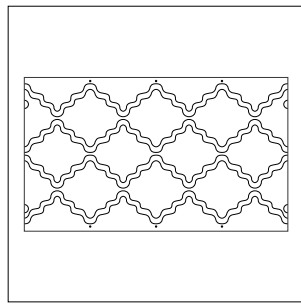

Ann Humphries Criss Cross
Single Row Size - 3" x 24"
© R&S Designs

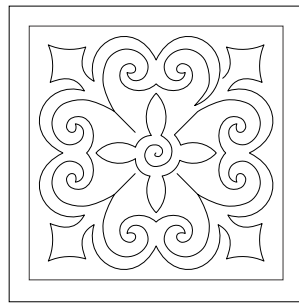

Ann Humphries Scroll Hearts - Block
Design Size - 11.5" x 11.5"
© R&S Designs

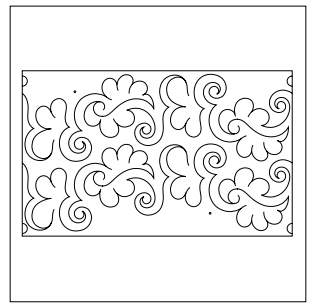

Antique Lace
Single Row Size - 6.5" x 20"
© Patricia E. Ritter

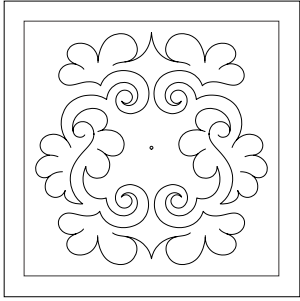

Antique Lace - Block #1
Design Size - 10" x 10"
© Patricia E. Ritter

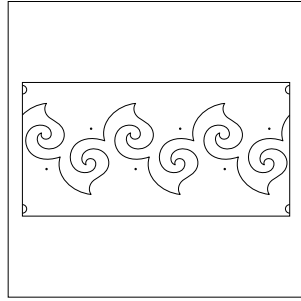

Apollo #1
Design Size - 8" x 23.5"
© Hermione Agee

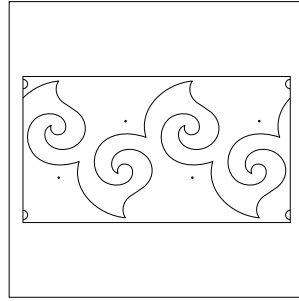

Apollo #2
Design Size - 11" x 21.5"
© Hermione Agee

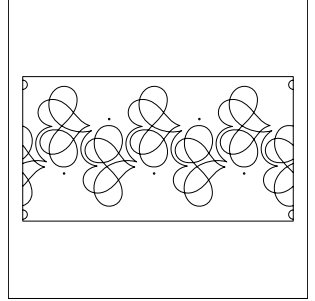

Appellation
Design Size - 9.75" x 22"
© Hermione Agee

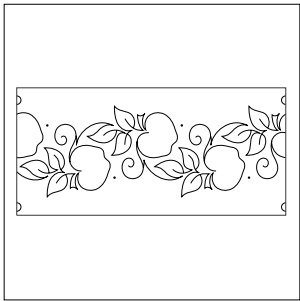

Apple Orchard
Design Size - 8" x 23.75"
© Patricia E. Ritter

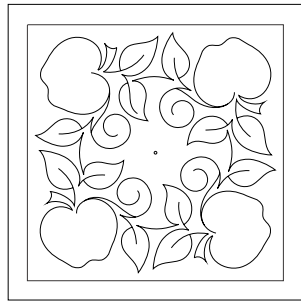

Apple Orchard - Block #1
Design Size - 11" x 11"
© Patricia E. Ritter

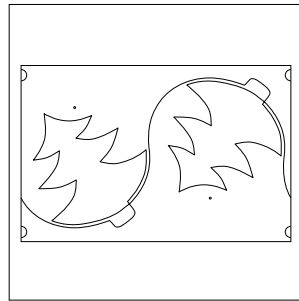

AM's Christmas Tree - Grande - Set
Set Size - 10" x 36"
© Apricot Moon Designs

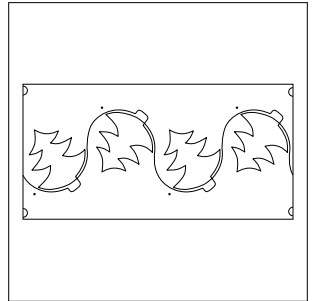

Apricot Moon's Christmas Tree
Design Size - 7.25" x 23.5"
© Apricot Moon Designs

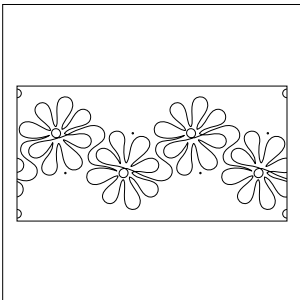

Apricot Moon's Daisy Doodles
Design Size - 9.75" x 23.5"
© Apricot Moon Designs

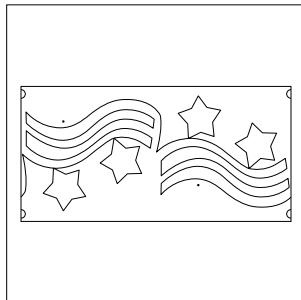

Apricot Moon's Freedom
Design Size - 10" x 23.5"
© Apricot Moon Designs

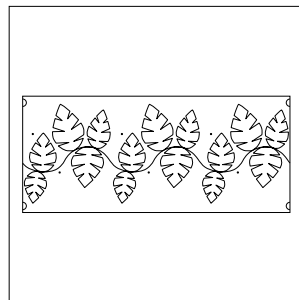

Apricot Moon's Jungle Vine
Design Size - 10" x 27"
© Apricot Moon Designs

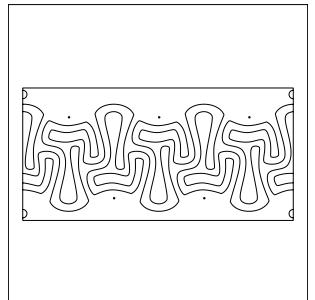

Apricot Moon's Sangria
Design Size - 9.5" x 24"
© Apricot Moon Designs

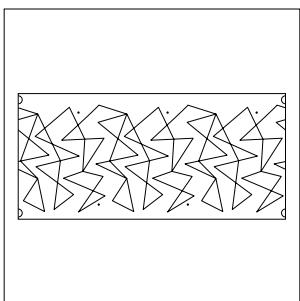

Apricot Moon's Wind Chimes
Design Size - 10" x 25"
© Apricot Moon Designs

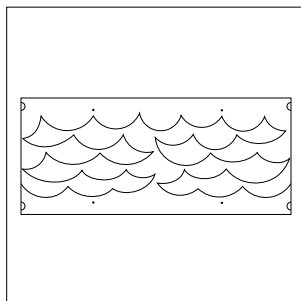

Aqua
Design Size - 8" x 25.5"
© Hermione Agee

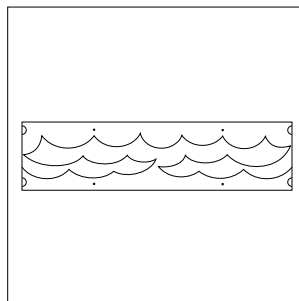

Aqua - Petite
Design Size - 4" x 23.75"
© Hermione Agee

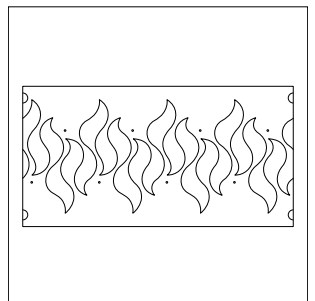

Aqua Flame
Design Size - 8.5" x 20.25"
© Hermione Agee

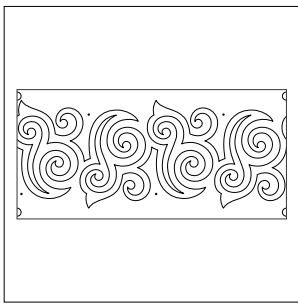

Aquarius
Design Size - 10" x 24.5"
© Patricia E. Ritter

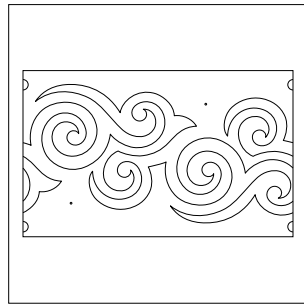

Aquarius #2
Design Size - 10" x 19.5"
© Patricia E. Ritter

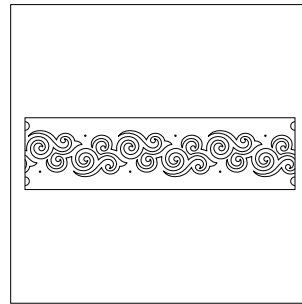

Aquarius - Petite
Design Size - 4" x 23.5"
© Patricia E. Ritter

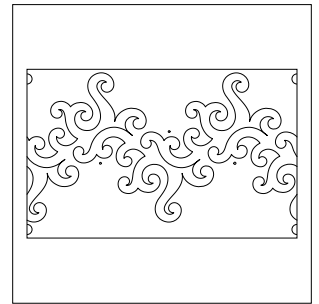

Arabesque
Design Size - 11" x 20"
© Patricia E. Ritter

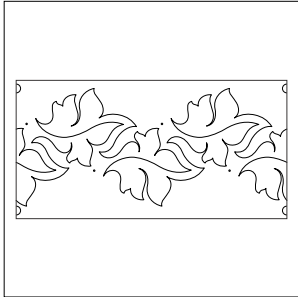

Aralia
Design Size - 10" x 23"
© Patricia E. Ritter

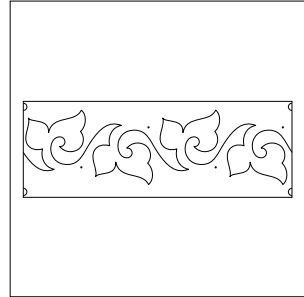

Arbour
Design Size - 7.75" x 28"
© Hermione Agee

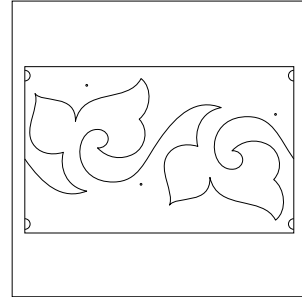

Arbour - Grande
Design Size - 10" x 19"
© Hermione Agee

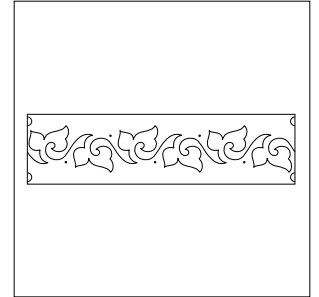

Arbour - Petite
Design Size - 4" x 23"
© Hermione Agee

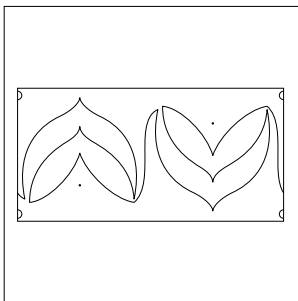

Archer
Design Size - 10" x 23.5"
© Hermione Agee

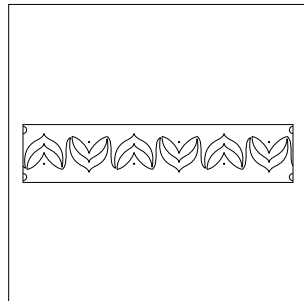

Archer - Petite
Design Size - 4" x 28"
© Hermione Agee

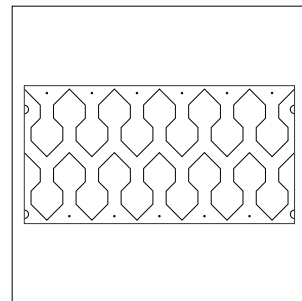

Argyle
Single Row Size - 6" x 24"
© Patricia E. Ritter

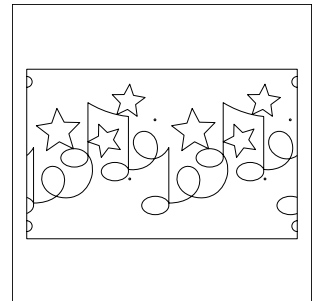

Aria
Design Size - 9" x 18.75"
© Mel St. Clair

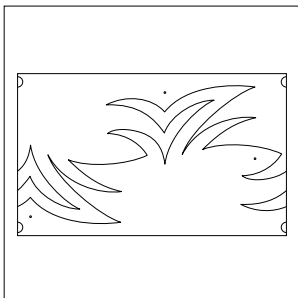

Arnica #1
Design Size - 10" x 19.5"
© Melonie J. Caldwell

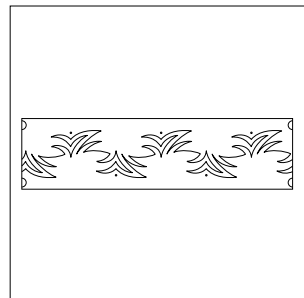

Arnica #2 - Petite
Design Size - 4" x 23"
© Melonie J. Caldwell

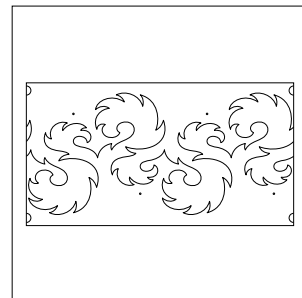

Aroma
Design Size - 10" x 22"
© Hermione Agee

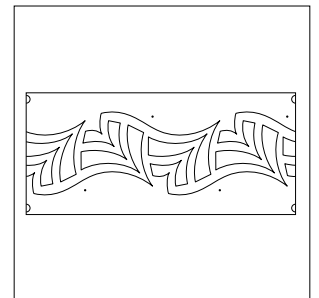

Arrowfull
Design Size - 8" x 26"
© Naomi Hynes

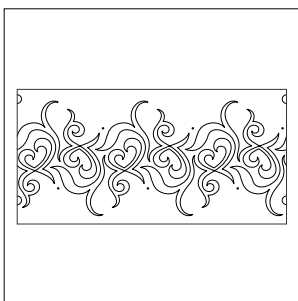

Art Heart
Design Size - 10" x 23.5"
© Hermione Agee

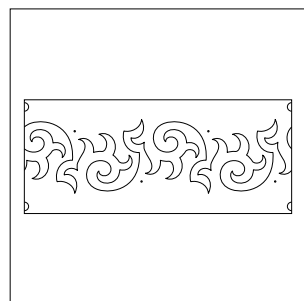

Artifact #1
Design Size - 6.5" x 23.5"
© Hermione Agee

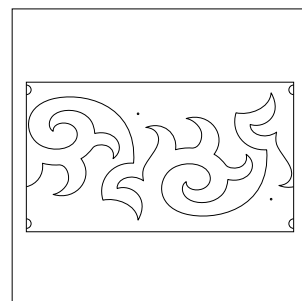

Artifact #2
Design Size - 10" x 21"
© Hermione Agee

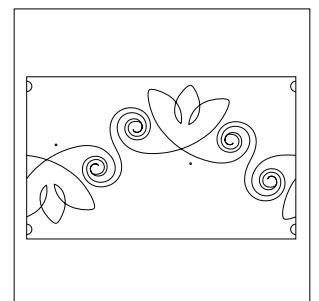

Asian Lily
Design Size - 10" x 19.5"
© Patricia E. Ritter & Megan Hahn

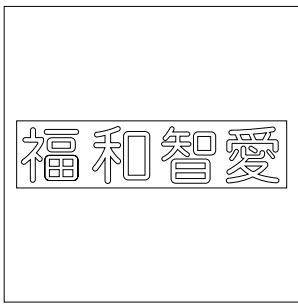

Asian Symbol - Block
Symbol Size - 5" x 5"

© R&S Designs

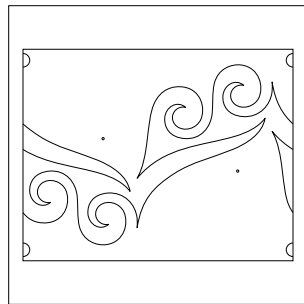

Asp - Set
Set Size - 10" x 30"

© Hermione Agee

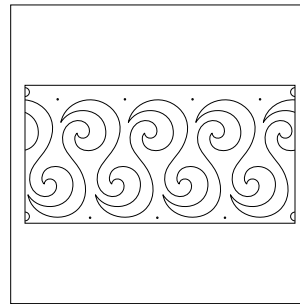

Asteroid
Design Size - 10" x 23"

© Hermione Agee

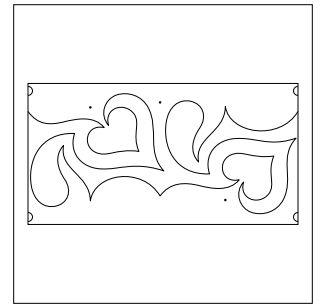

Athos
Design Size - 10" x 22.5"

© Hermione Agee

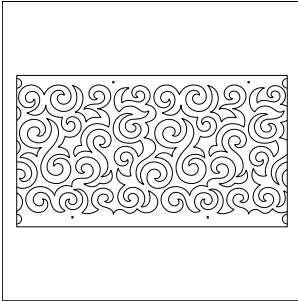

Atlantic
Design Size - 10.25" x 21"

© Patricia E. Ritter & Denise Schillinger

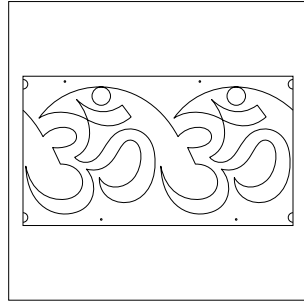

Aum
Design Size - 10" x 21.25"

© Hermione Agee

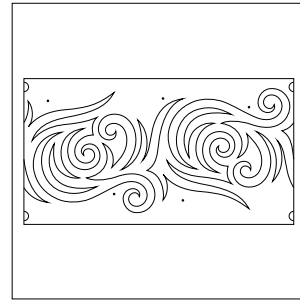

Aurora
Design Size - 10" x 21.75"

© Patricia E. Ritter & Valerie Smith

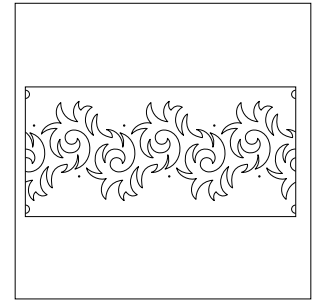

Axis
Design Size - 9" x 24.5"

© Hermione Agee

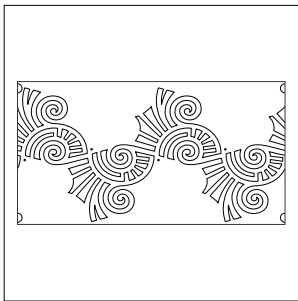

Ba Da Bing
Design Size - 11" x 22"

© Patricia E. Ritter

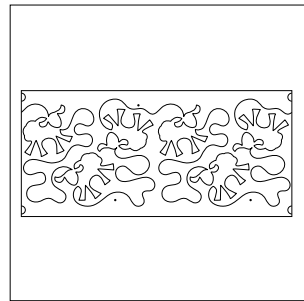

BAAA!
Design Size - 10" x 25.25"

© Apricot Moon Designs

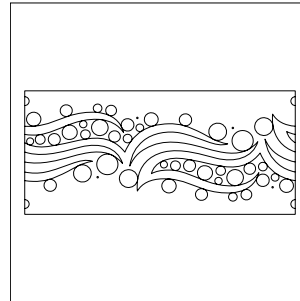

Bahia
Design Size - 8.25" x 21.25"

© Patricia E. Ritter

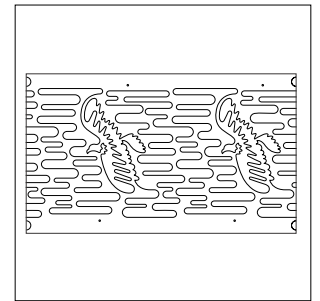

Bald Eagle
Design Size - 10.5" x 22"

© Laura Estes

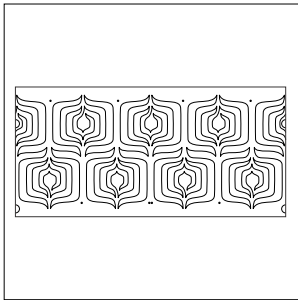

Bali
Design Size - 10.5" x 25"

© Patricia E. Ritter & Marybeth O'Halloran

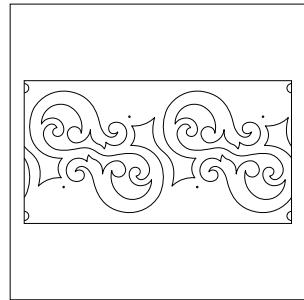

Bali Frond
Design Size - 10" x 22"

© Naomi Hynes

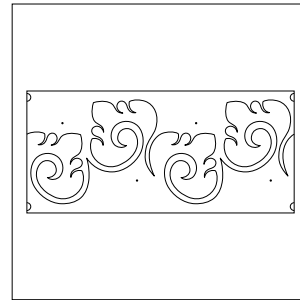

Bali Stone
Design Size - 10" x 25.75"

© Naomi Hynes

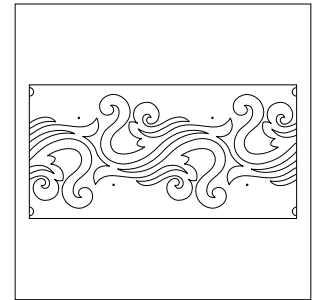

Bali Swan
Design Size - 10" x 23.5"

© Naomi Hynes

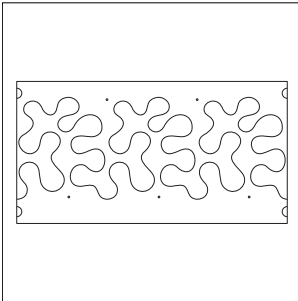

Bam!
Design Size - 7.5" x 20"

© Jessica Schick

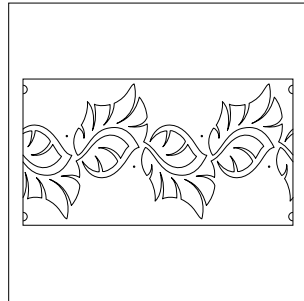

Banana Leaves
Design Size - 10" x 23.75"

© Patricia E. Ritter

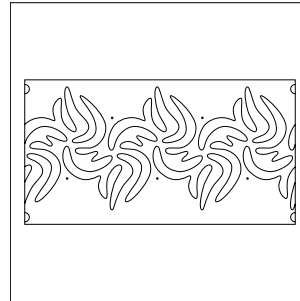

Banana Swirls
Design Size - 10" x 22"

© Barbara Becker

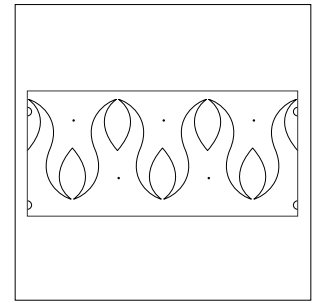

Bangkok
Design Size - 8.75" x 23.75"

© Sarah Ann Myers

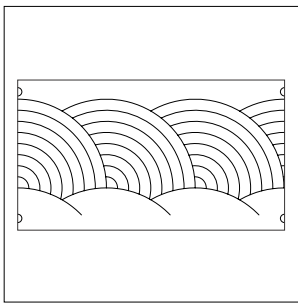

Baptist Fan - Grande
Design Size - 10.5" x 24"
© R&S Designs

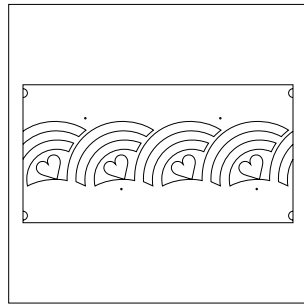

Baptist Heart Fan
Design Size - 5.5" x 23"
© Kristin Hoffzyer

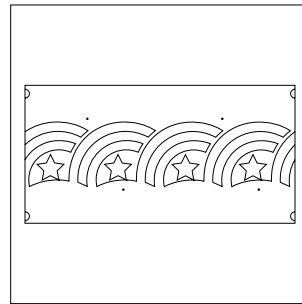

Baptist Star Fan
Design Size - 5.5" x 23"
© Kristin Hoffzyer

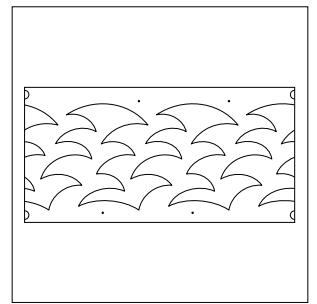

Barb
Design Size - 9.25" x 23.5"
© Hermione Agee

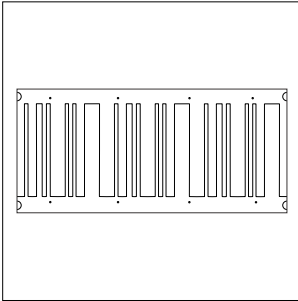

Barcode
Design Size - 8.25" x 24"
© Patricia E. Ritter

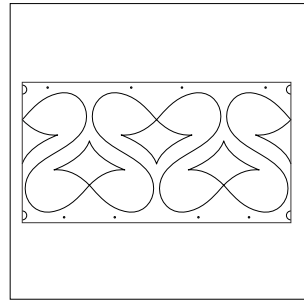

Baroque Hearts
Design Size - 10" x 22.5"
© Keryn Emmerson

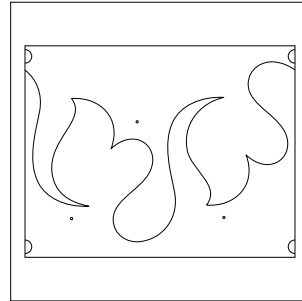

Basal - Set
Set Size - 10" x 30"
© Hermione Agee

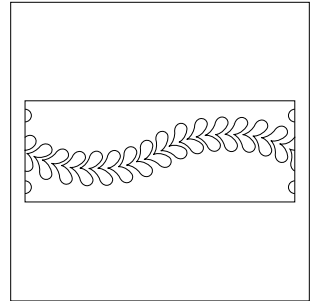

Base Feather
Design Size - 4" x 16"
© R&S Designs

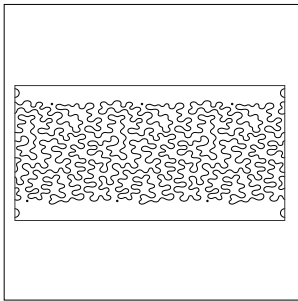

Basic Stipple
Design Size - 9" x 23.5"
© Quilting Creations

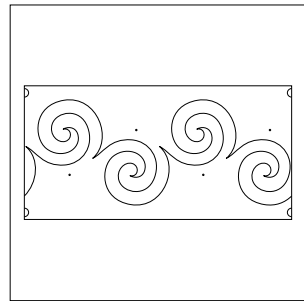

Basic Swirl
Design Size - 9.25" x 23.5"
© Quilters Apothecary

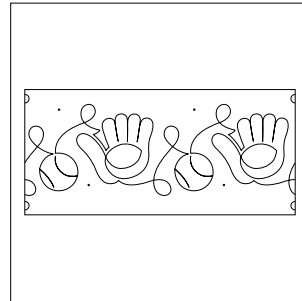

Batter Up
Design Size - 8" x 23.75"
© Patricia E. Ritter

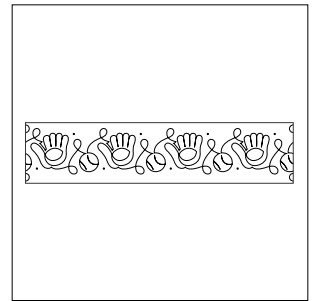

Batter Up - Petite
Design Size - 4.5" x 26.5"
© Patricia E. Ritter

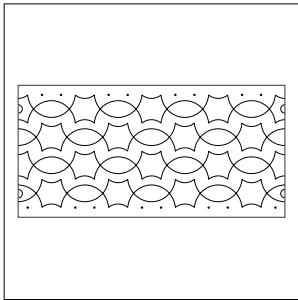

Batty
Single Row Size - 2.5" x 23.75"
© R&S Designs

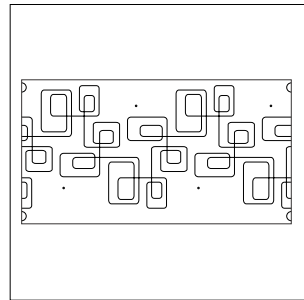

Bauhaus
Design Size - 10" x 22"
© Patricia E. Ritter

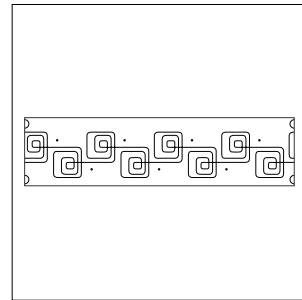

Bauhaus Baby
Design Size - 4" x 23.75"
© Patricia E. Ritter & Denise Schillinger

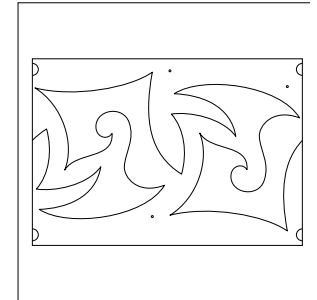

Bayonet - Set
Set Size - 10" x 34"
© Hermione Agee

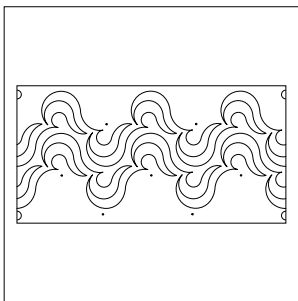

Bayside
Single Row Size - 6.5" x 23"
© Hermione Agee

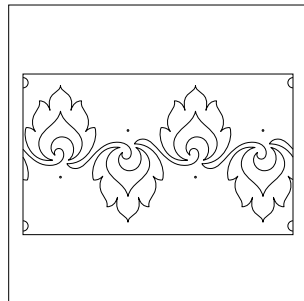

Beacon
Design Size - 10" x 19.75"
© Hermione Agee

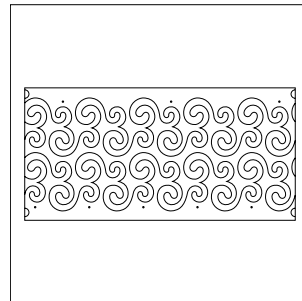

Beaded Curtain
Single Row Size - 5.25" x 24"
© Barbara Becker

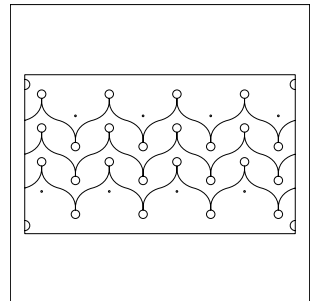

Beaded Knit
Single Row Size - 4.5" x 20"
© Melissa Kelley

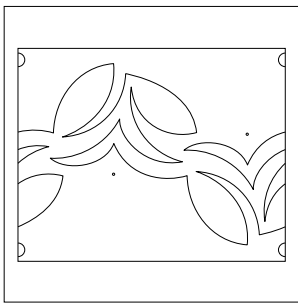

Bean Sprout - Set
Set Size - 10" x 29.5"
© Sarah Ann Myers

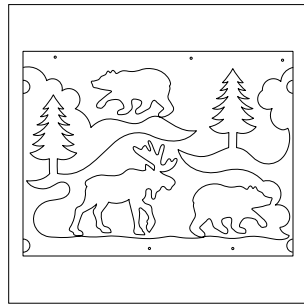

Bear, Moose and Pines - Set
Set Size - 10" x 31"
© Deb Geissler

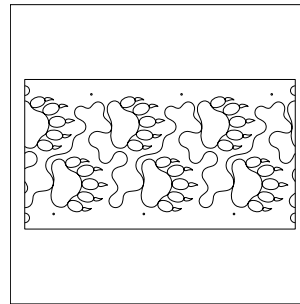

Bear Paw
Design Size - 9" x 21.25"
© Jessica Schick

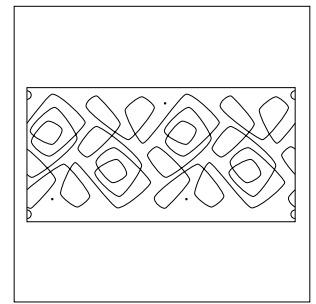

Beau Jangles
Design Size - 10" x 23.5"
© Apricot Moon Designs

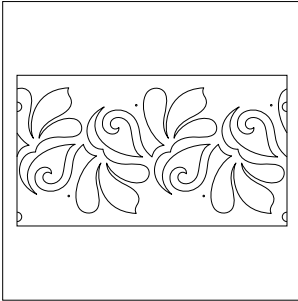

Beauty
Design Size - 10" x 21.5"
© Hermione Agee

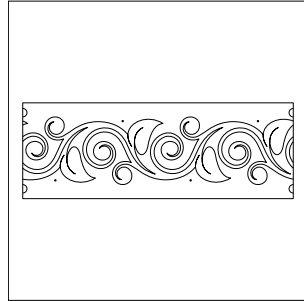

Beaux-Arts
Design Size - 6" x 24"
© Patricia E. Ritter & Jeffery Schillinger

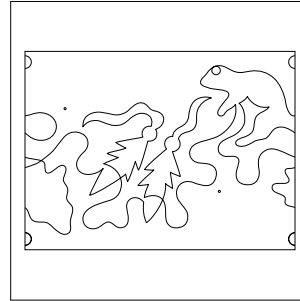

Beaver Creek - Set
Set Size - 10" x 32"
© Dave Hudson

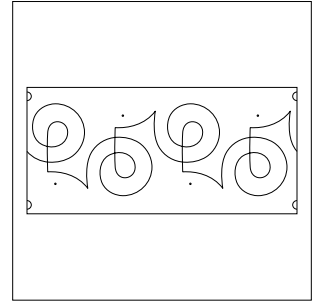

Bebop
Design Size - 8" x 23.5"
© Sarah Ann Myers

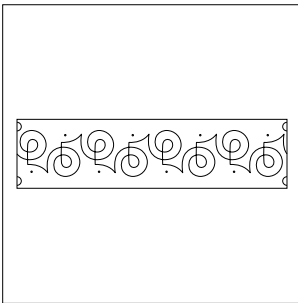

Bebop - Petite
Design Size - 4" x 23.5"
© Sarah Ann Myers

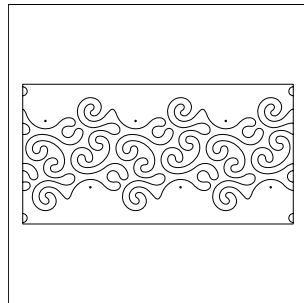

Becker's Birds Eye View
Design Size - 9.5" x 22.75"
© Barbara Becker

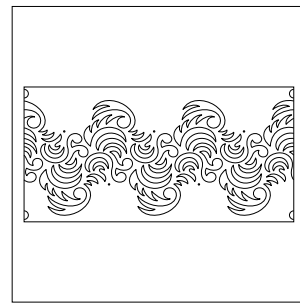

Becker's Dragon's Tail
Design Size - 10" x 23.5"
© Barbara Becker

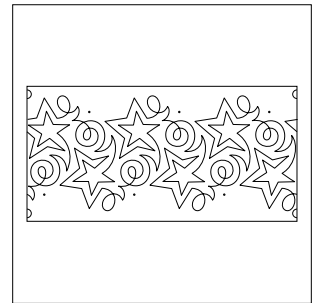

Becker's Shooting Star
Design Size - 10" x 23.5"
© Barbara Becker

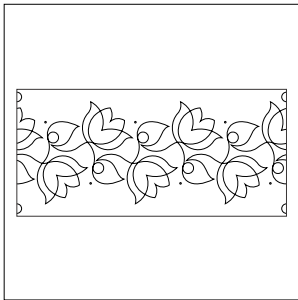

Belladonna
Design Size - 8" x 21.25"
© Hermione Agee

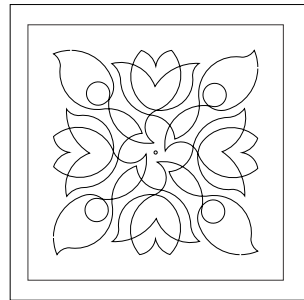

Belladonna - Block #1
Design Size - 8" x 8"
© Hermione Agee

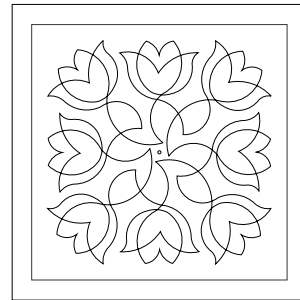

Belladonna - Block #2
Design Size - 8.75" x 8.75"
© Hermione Agee

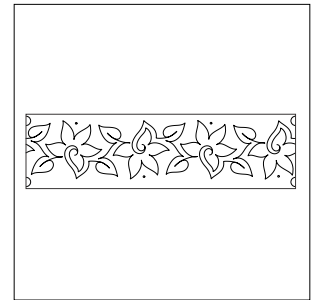

Bellflower
Design Size - 4.75" x 21.75"
© Patricia E. Ritter

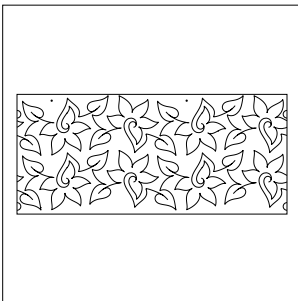

Bellflower - Double Row
Single Row Size - 5.75" x 26.5"
© Patricia E. Ritter

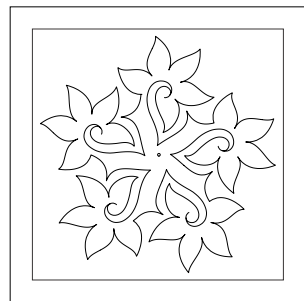

Bellflower - Block #2
Design Size - 11" x 11"
© Patricia E. Ritter

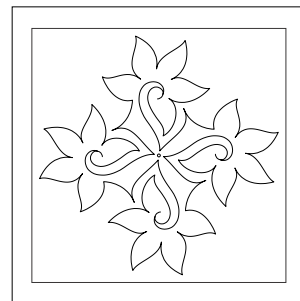

Bellflower - Block #3
Design Size - 10.5" x 10.5"
© Patricia E. Ritter

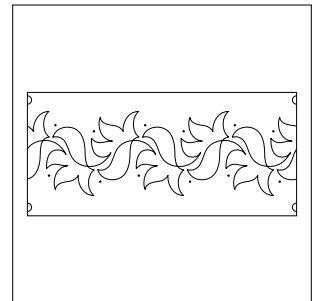

Bellini
Design Size - 7.5" x 24"
© Patricia E. Ritter

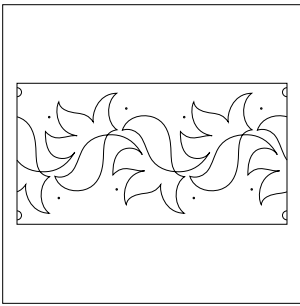

Bellini - Grande
Design Size - 10" x 22.5"
© Patricia E. Ritter

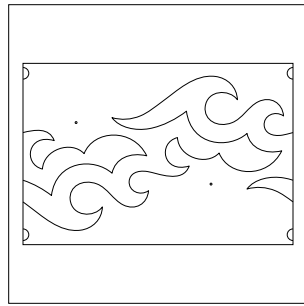

Bells Beach - Set
Set Size - 10" x 35"
© Hermione Agee

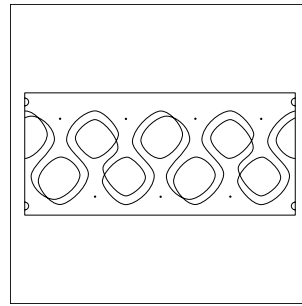

Belly Bop
Design Size - 9" x 26"
© Apricot Moon Designs

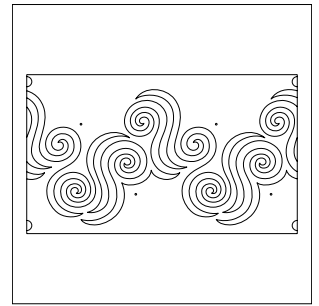

Benay's Curls
Design Size - 10" x 20"
© Beany Girl Quilts

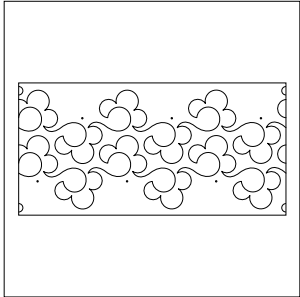

Billowy
Single Row Size - 6.5" x 23.75"
© Hermione Agee

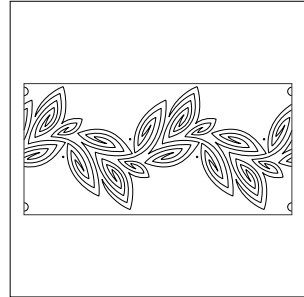

Birchwood
Design Size - 11" x 24"
© Patricia E. Ritter & Leisha Farnsworth

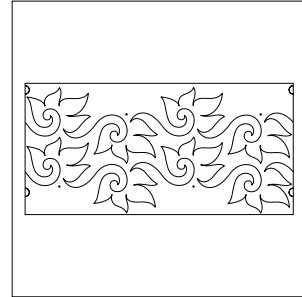

Bird of Paradise
Single Row Size - 6.75" x 24"
© Patricia E. Ritter

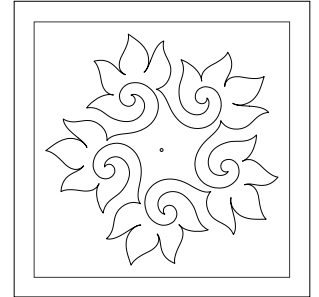

Bird of Paradise - Block
Design Size - 10" x 10"
© Patricia E. Ritter

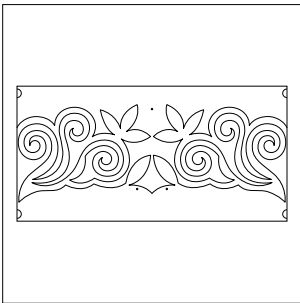

Birds in a Nest
Design Size - 8.5" x 23.5"
© Claudia Pfeil

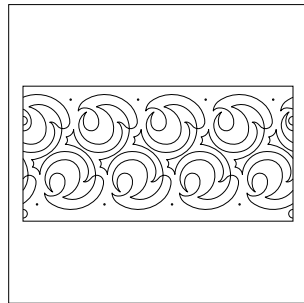

Birdseye
Design Size - 10" x 23.5"
© Keryn Emmerson

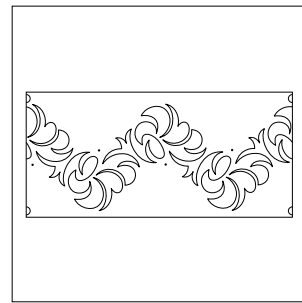

Bisque
Design Size - 10" x 25"
© Sarah Ann Myers

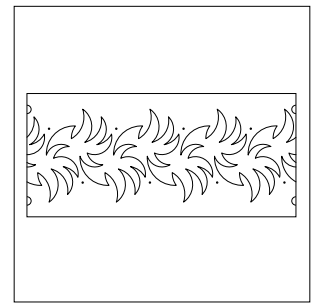

Blackberry
Design Size - 8.25" x 24"
© Hermione Agee

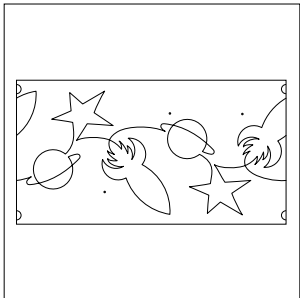

Blast Off
Design Size - 10" x 22"
© Hermione Agee

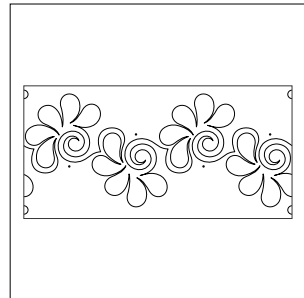

Blissful
Design Size - 10" x 23.75"
© Sarah Ann Myers

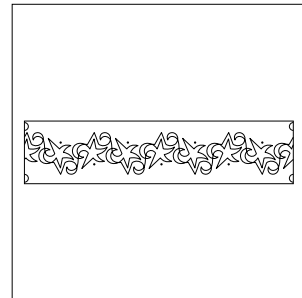

Blue Star - Petite
Design Size - 4" x 25.75"
© Patricia E. Ritter & OESD

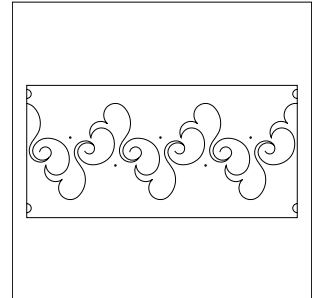

Bluster
Design Size - 8" x 22.5"
© Hermione Agee

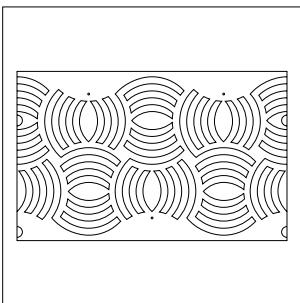

Bobbing for Apples - Set
Set Size - 11" x 37.5"
© Patricia E. Ritter

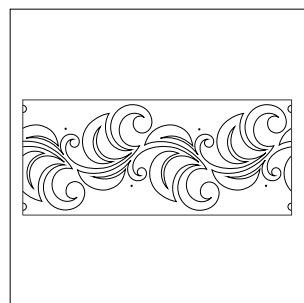

Bohemian Leaves
Design Size - 11" x 28"
© Patricia E. Ritter

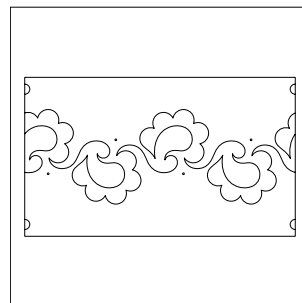

Boho Plume
Design Size - 7" x 20"
© Hermione Agee

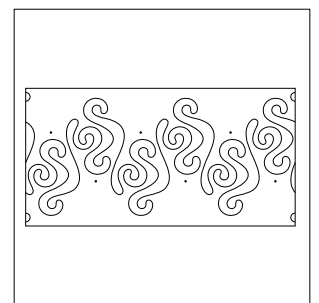

Bolero
Design Size - 10" x 23"
© Sarah Ann Myers

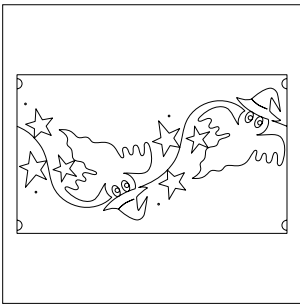

Boo
Design Size - 9.75" x 20"
© Melonie J. Caldwell

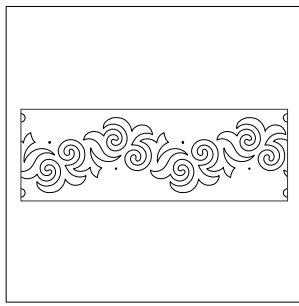

Bordeaux
Design Size - 6.75" x 24"
© Sarah Ann Myers

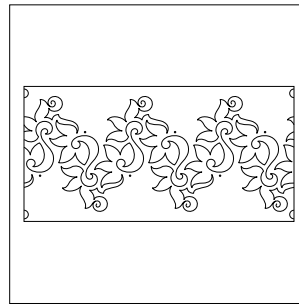

Borneo
Design Size - 10" x 23.5"
© Hermione Agee

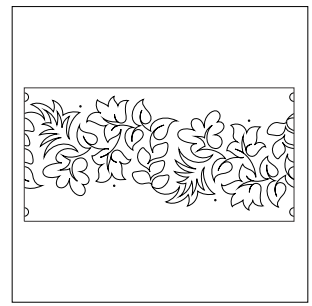

Botanical Gardens
Design Size - 10" x 23.75"
© Patricia E. Ritter

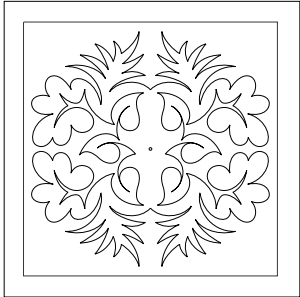

Botanical Gardens - Block #1
Design Size - 11" x 11"
© Patricia E. Ritter

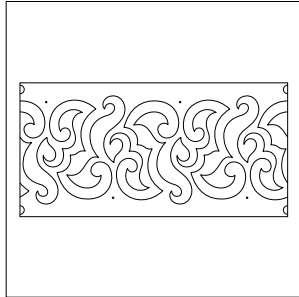

Botany
Design Size - 9.5" x 23.5"
© Hermione Agee

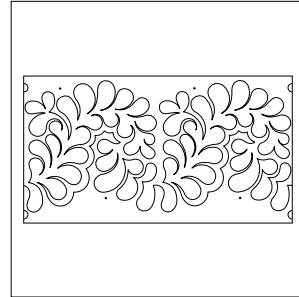

Bountiful Feathers
Design Size - 11.75" x 23.75"
© Hermione Agee

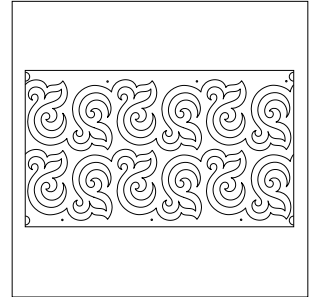

Bourbon Street Baby
Single Row Size - 6" x 22.75"
© Patricia E. Ritter

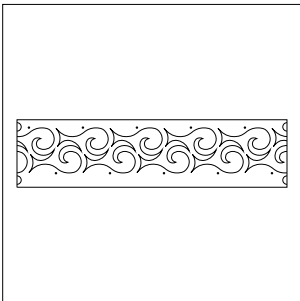

Breath of the Gods
Design Size - 4" x 24"
© Apricot Moon Designs

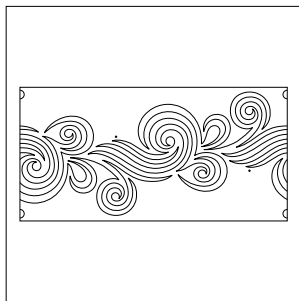

Breeze
Design Size - 10.75" x 23.5"
© Patricia E. Ritter & Leisha Farnsworth

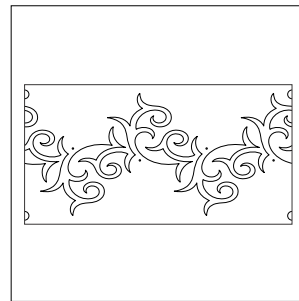

Briar
Design Size - 10.5" x 23"
© Patricia E. Ritter & Tracey Russell

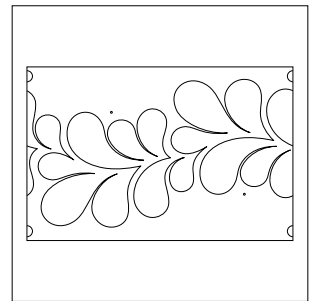

Brocade - Set
Set Size - 10" x 36"
© Patricia E. Ritter

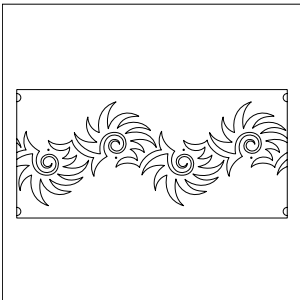

Bromeliad
Design Size - 9.5" x 24.75"
© Sarah Ann Myers

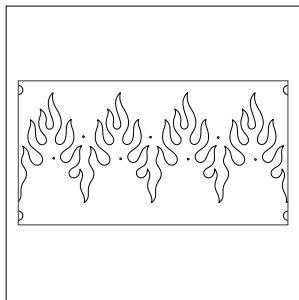

Brush Fire
Design Size - 9" x 22"
© Nancy Read

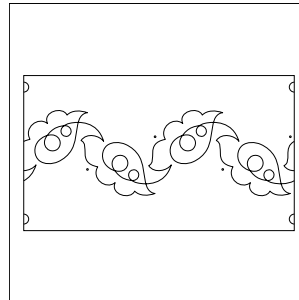

Bubble Tea
Design Size - 6.5" x 20.5"
© Hermione Agee

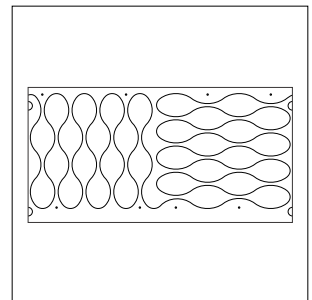

Bubble Weave
Design Size - 10" x 23"
© Jessica Schick

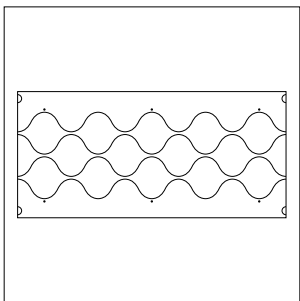

Bubble Wrap - Double Take
Single Row Size - 1.75" x 25"
© Patricia E. Ritter & Leisha Farnsworth

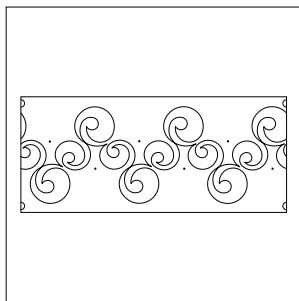

Bubbles
Design Size - 9.75" x 27"
© Hermione Agee

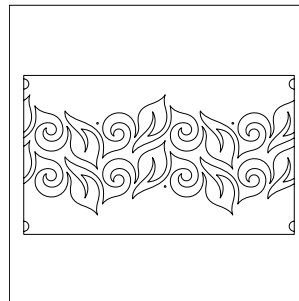

Buena
Single Row Size - 5.5" x 20"
© Hermione Agee

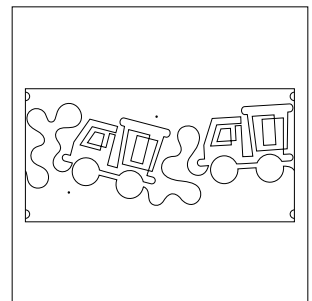

Built Tough
Design Size - 9" x 23.75"
© Patricia E. Ritter

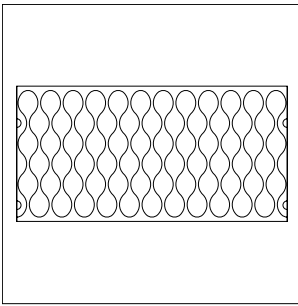

Bump and Squeeze
Design Size - 11" x 23.5"
© Jessica Schick

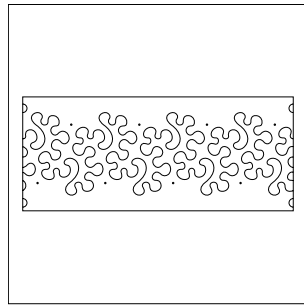

Bumpity
Design Size - 7.25" x 23.75"
© Barbara Becker

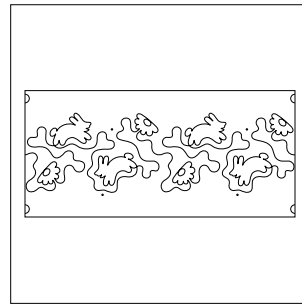

Bunny Hop
Design Size - 7" x 23.5"
© Dave Hudson

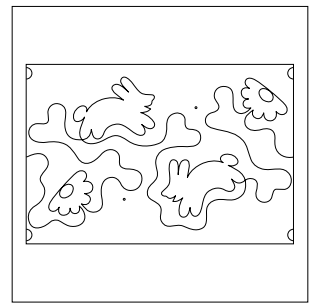

Bunny Hop - Set
Set Size - 10" x 35"
© Dave Hudson

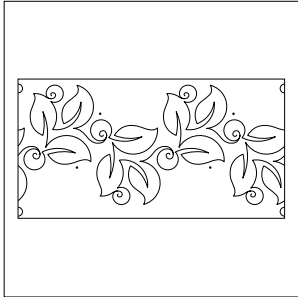

Bush Berries
Design Size - 10" x 22.5"
© Hermione Agee

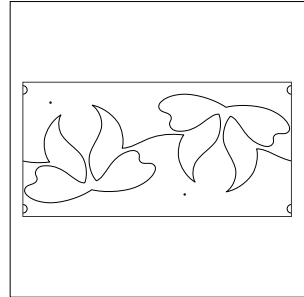

Bustle - Grande
Design Size - 9.5" x 23.5"
© Hermione Agee

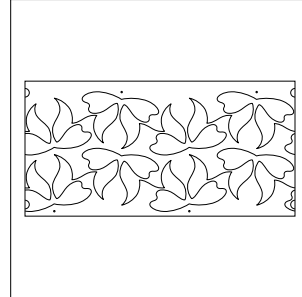

Bustle - Petite - Double Row
Single Row Size - 5.5" x 23.5"
© Hermione Agee

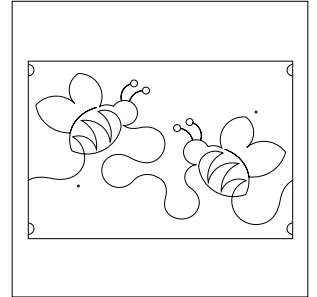

Busy Bees - Set
Set Size - 10" x 35"
© Hermione Agee

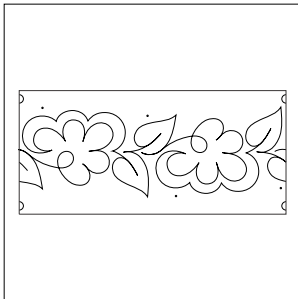

Buttercup
Design Size - 8" x 23.75"
© Patricia E. Ritter

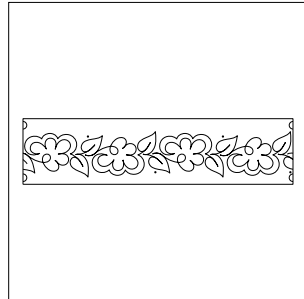

Buttercup - Petite
Design Size - 4.5" x 26.75"
© Patricia E. Ritter

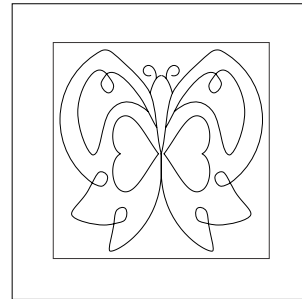

Butterfly - Block - Small
Design Size - 7.5" x 7.5"
© R&S Designs

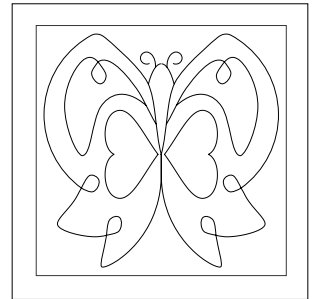

Butterfly - Block - Large
Design Size - 12" x 12"
© R&S Designs

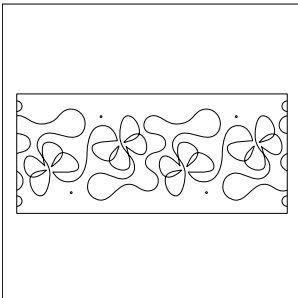

Butterfly Waltz
Design Size - 6.5" x 19.25"
© Apricot Moon Designs

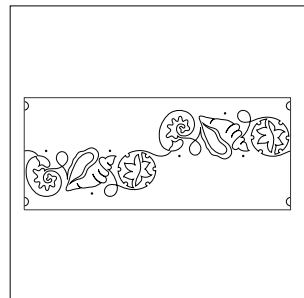

By the Seashore
Design Size - 7.75" x 23.75"
© Patricia E. Ritter

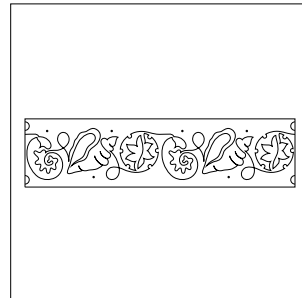

By the Seashore - Petite
Design Size - 4.5" x 23.75"
© Patricia E. Ritter

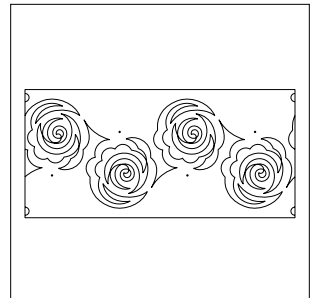

Cabbage Rose
Design Size - 10" x 24.75"
© Sarah Ann Myers

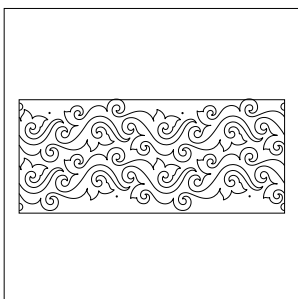

Cafe du Monde
Single Row Size - 6.5" x 27.5"
© Patricia E. Ritter

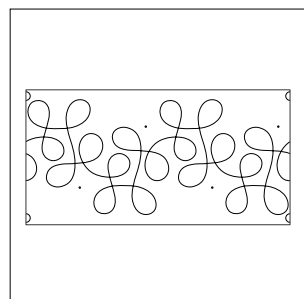

Cakewalk
Design Size - 10" x 23"
© Sarah Ann Myers

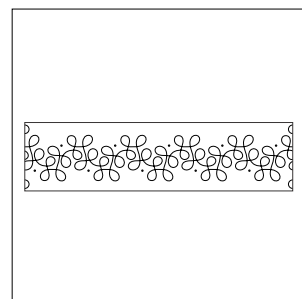

Cakewalk - Petite
Design Size - 4" x 23.5"
© Sarah Ann Myers

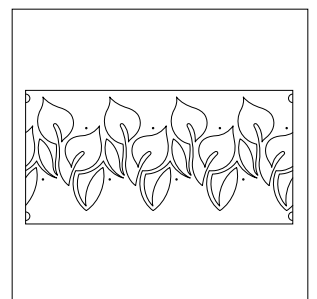

Calla Lily
Design Size - 10" x 23.5"
© Hermione Agee

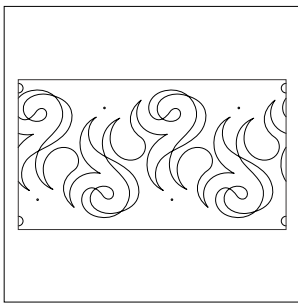

Calligraphy
Design Size - 10" x 21"
© Hermione Agee

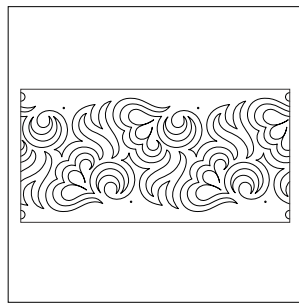

Calliope
Design Size - 10" x 23.75"
© Patricia E. Ritter

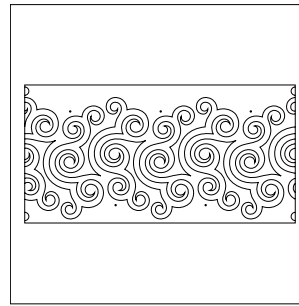

Calypso
Design Size - 11" x 24.5"
© Patricia E. Ritter

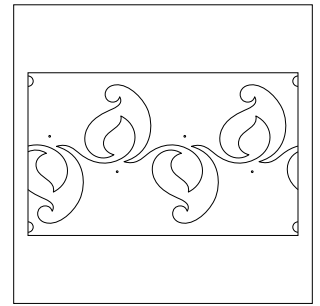

Candle
Design Size - 10" x 19.5"
© Hermione Agee

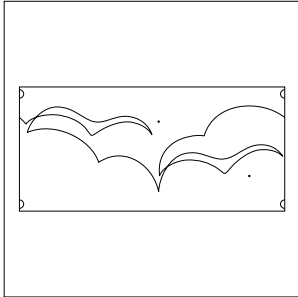

Cape Cod
Design Size - 7.5" x 23.5"
© Melonie J. Caldwell

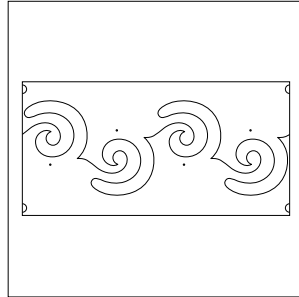

Caramel
Design Size - 8.25" x 23.5"
© Patricia E. Ritter & Judy Borger

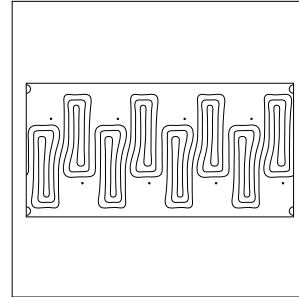

Card Trix
Design Size - 10" x 23.5"
© Mary Eddy / Jelly Bean

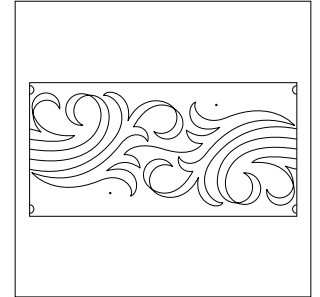

Cardamom Wave
Design Size - 10" x 23.5"
© Jessica Schick

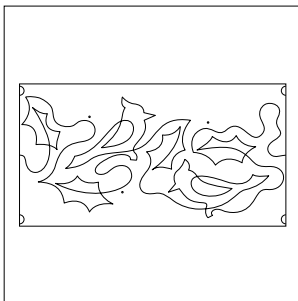

Cardinals
Design Size - 10" x 22"
© Dave Hudson

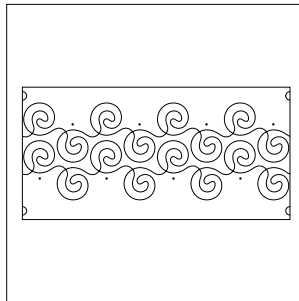

Cartwheel
Single Row Size - 5.25" x 23.75"
© Sarah Ann Myers

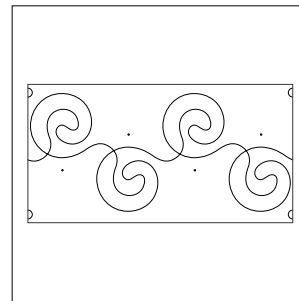

Cartwheel - Grande
Design Size - 10" x 22.5"
© Sarah Ann Myers

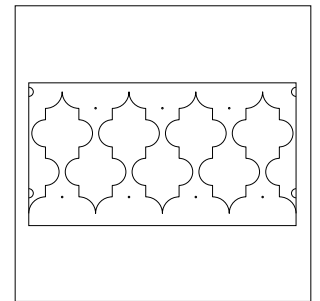

Casablanca
Design Size - 10" x 22"
© Melonie J. Caldwell

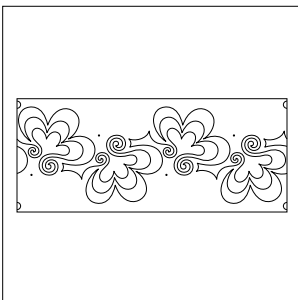

Cascade
Design Size - 10" x 28"
© Hermione Agee

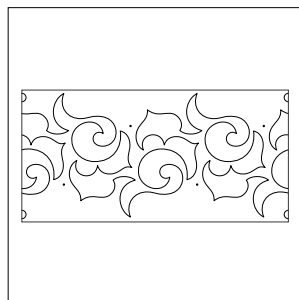

Caspian
Design Size - 11" x 23.75"
© Hermione Agee

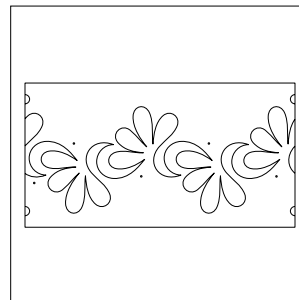

Cassava
Design Size - 8.75" x 22"
© Sarah Ann Myers

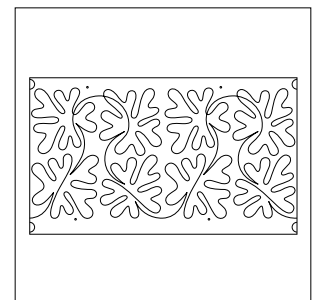

Catnip
Design Size - 10" x 20.5"
© Patricia E. Ritter

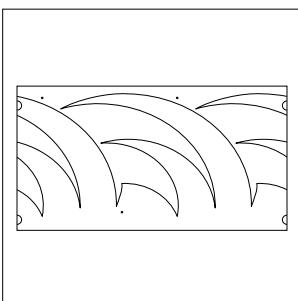

Catscratch
Design Size - 10" x 22"
© Keryn Emmerson

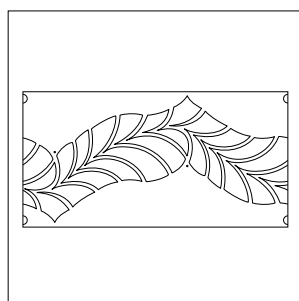

Cedar
Design Size - 11" x 23"
© Patricia E. Ritter & Leisha Farnsworth

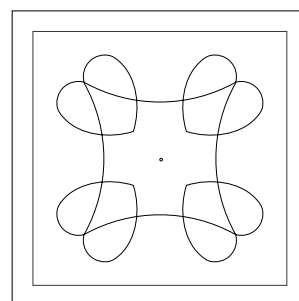

Celtic Heart - Block
Design Size - 9.5" x 9.5"
© R&S Designs

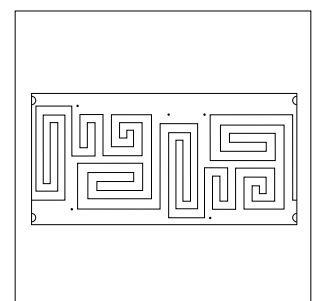

Celtic Maze
Design Size - 10" x 23.75"
© Patricia E. Ritter & Marybeth O'Halloran

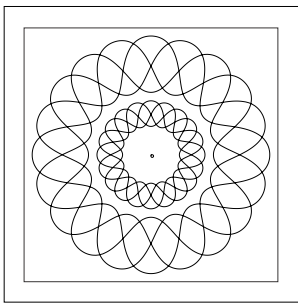

Celtic Ring - Block
Design Size - 5" and 11"
© R&S Designs

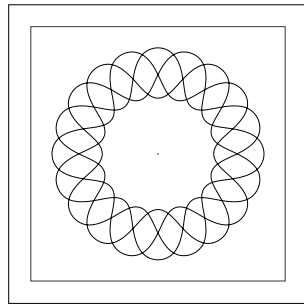

Celtic Ring - Block - Small
Design Size - 5" x 5"
© R&S Designs

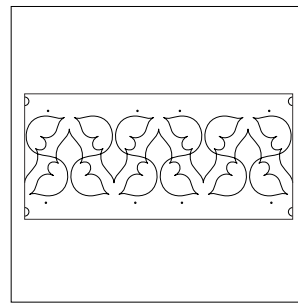

Ceylon
Design Size - 7" x 23.5"
© Hermione Agee

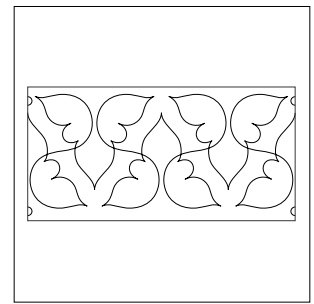

Ceylon - Grande
Design Size - 10" x 23.5"
© Hermione Agee

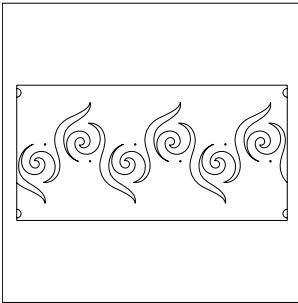

Cha-Cha
Design Size - 8.75" x 23.5"
© Melonie J. Caldwell

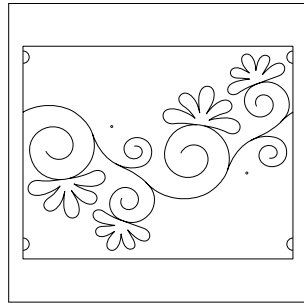

Chantilly - Set
Set Size - 12" x 33"
© Patricia E. Ritter & Leisha Farnsworth

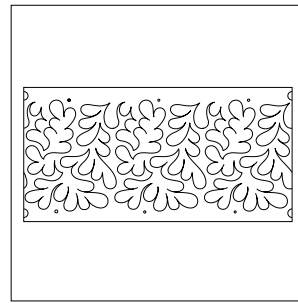

Chaparral
Design Size - 9.75" x 23.5"
© Patricia E. Ritter

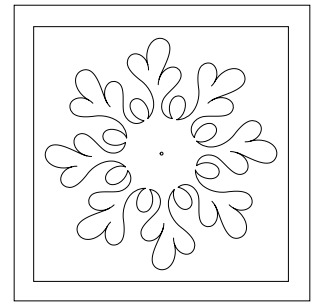

Chaparral - Block #1
Design Size - 10" x 10"
© Patricia E. Ritter

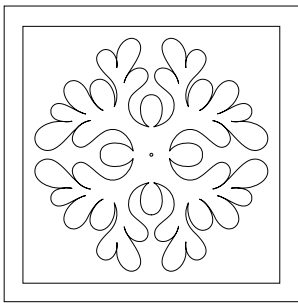

Chaparral - Block #2
Design Size - 10" x 10"
© Patricia E. Ritter

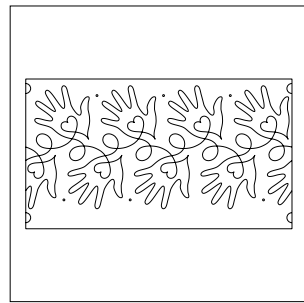

Charity
Design Size - 9.25" x 20"
© Patricia E. Ritter

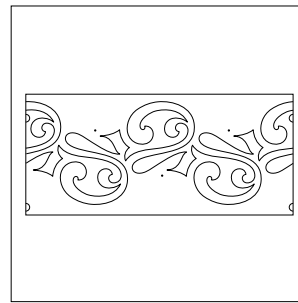

Charleston
Design Size - 10" x 26"
© Hermione Agee

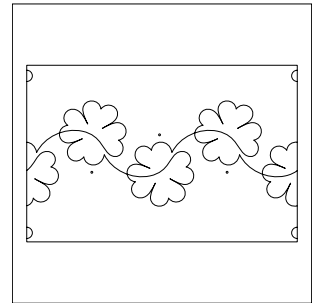

Charmed - Again
Design Size - 7" x 18"
© Melonie J. Caldwell

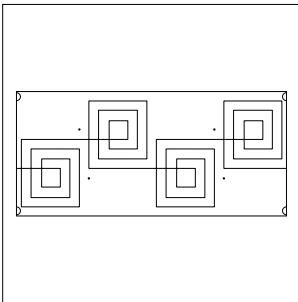

Checkedered Plaid
Design Size - 10" x 25.5"
© Patricia E. Ritter

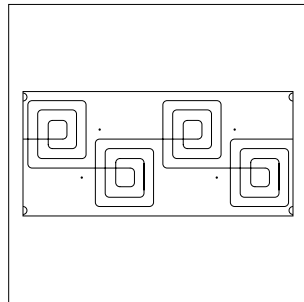

Checkedered Plaid - Bias Cut
Design Size - 10" x 25.5"
© Patricia E. Ritter

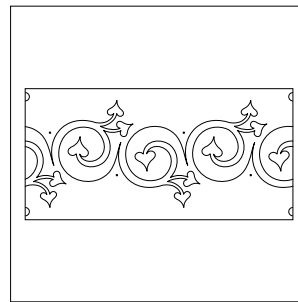

Cherish
Design Size - 9.5" x 24"
© Hermione Agee

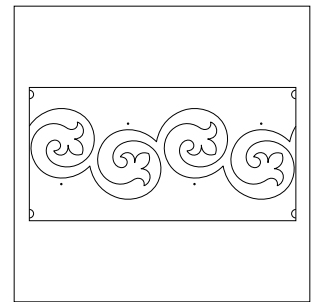

Chevalier
Design Size - 8" x 23"
© Hermione Agee

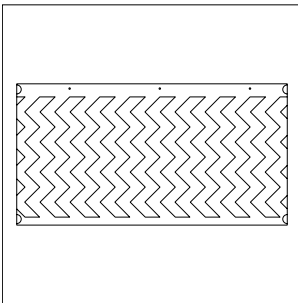

Chevron
Design Size - 10" x 22.5"
© Melonie J. Caldwell

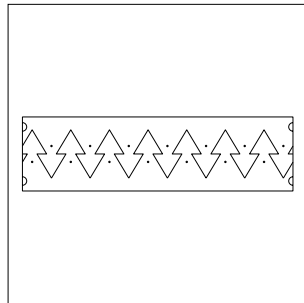

Chevron Remix
Design Size - 4.25" x 23.75"
© Mel St. Clair

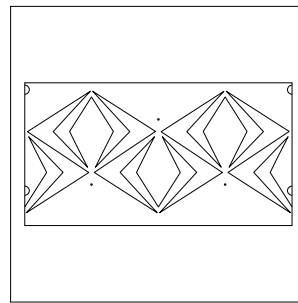

Chevron Tumblers
Design Size - 10" x 22"
© Patricia E. Ritter & Marybeth O'Halloran

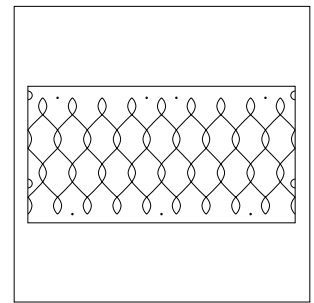

Chicken Wire
Design Size - 10" x 23"
© Patricia E. Ritter

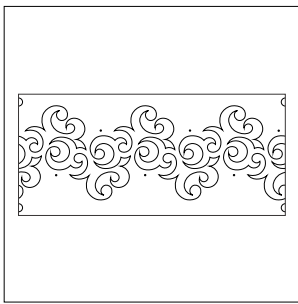

Chinook
Design Size - 8.75" x 24.75"
© Denise Schillinger

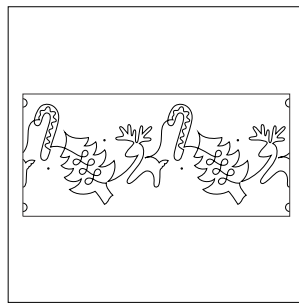

Christmas Cookies
Design Size - 9" x 24"
© Patricia E. Ritter

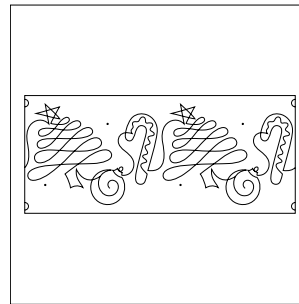

Christmas Doodle
Design Size - 10" x 27"
© Patricia E. Ritter

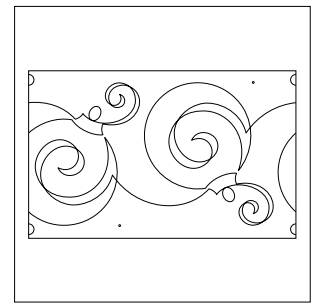

Christmas Doodle - Ornaments - Set
Set Size - 10" x 37.5"
© Patricia E. Ritter

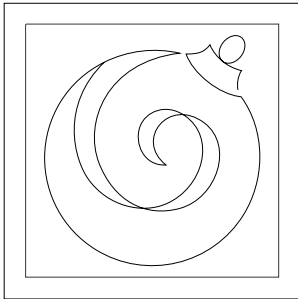

Christmas Doodle - Ornament
Design Size - 9.5" x 10"
© Patricia E. Ritter

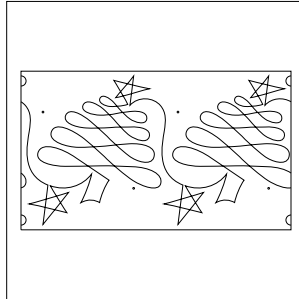

Christmas Doodle - Trees
Design Size - 11" x 20"
© Patricia E. Ritter

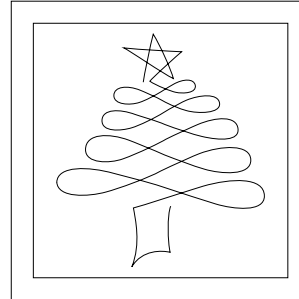

Christmas Doodle - Tree - Block
Design Size - 9" x 10"
© Patricia E. Ritter

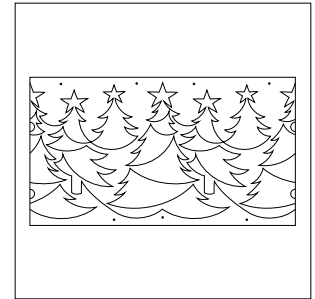

Christmas Forest
Design Size - 11" x 21.5"
© Hermione Agee

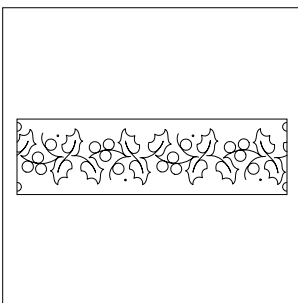

Christmas Holly - Petite
Design Size - 4.75" x 23.25"
© Patricia E. Ritter

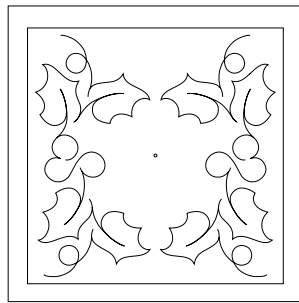

Christmas Holly - Block
Design Size - 11" x 11"
© Patricia E. Ritter

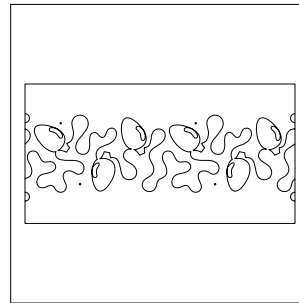

Christmas Lights
Design Size - 6.5" x 22.75"
© Dave Hudson

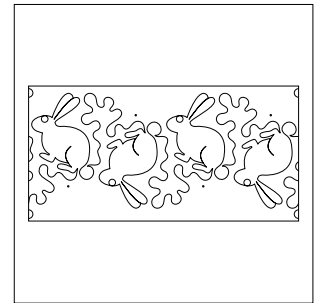

Chubby Bunnies
Design Size - 10" x 23.5"
© Thomas Schick

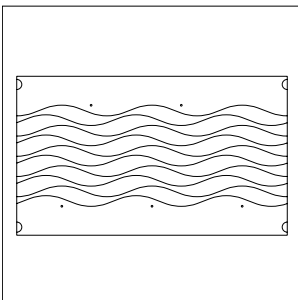

Cindy's Water
Double Row Size - 1.5" x 20"
© It's A Quilt Thing

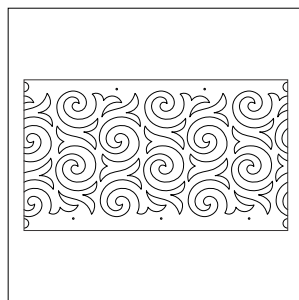

Cinnamon Swirl
Design Size - 10" x 21"
© Apricot Moon Designs

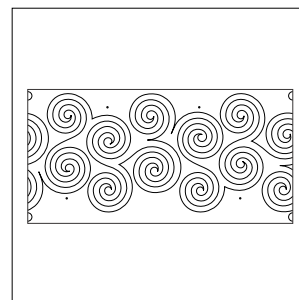

Circle of Life
Design Size - 10.5" x 23.75"
© Patricia E. Ritter

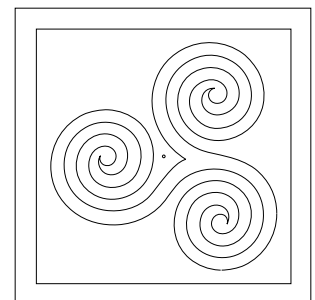

Circle of Life - Block
Design Size - 10.5" x 10.5"
© Patricia E. Ritter

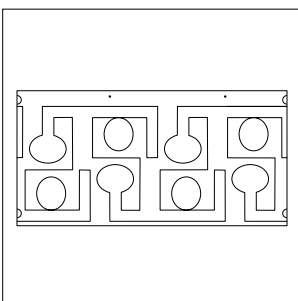

Circuitry
Design Size - 10" x 23.5"
© Melonie J. Caldwell

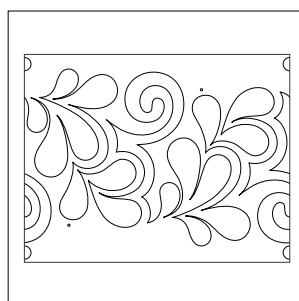

Citrine - Set
Set Size - 10" x 30"
© Patricia E. Ritter

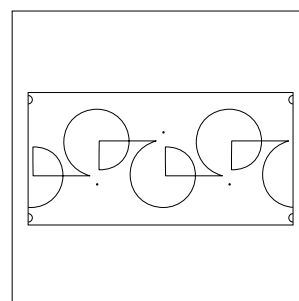

Citrus
Design Size - 8.75" x 23.5"
© Sarah Ann Myers

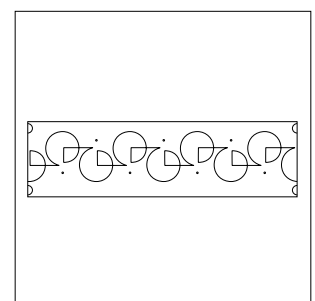

Citrus - Petite
Design Size - 4" x 21.5"
© Sarah Ann Myers

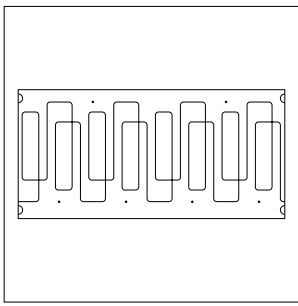

City Windows
Design Size - 8.5" x 22.75"
© Apricot Moon Designs

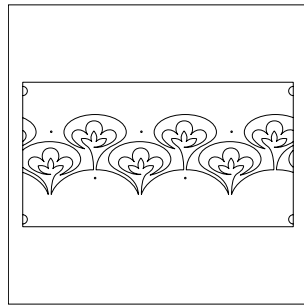

Clamflower
Design Size - 6.5" x 22"
© Lisa Gates / Threadsongs

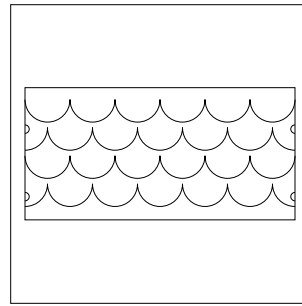

Clamshell #2
Single Row Size - 2" x 24"

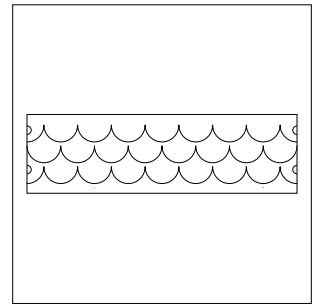

Clamshell #3
Single Row Size - 1.5" x 24"

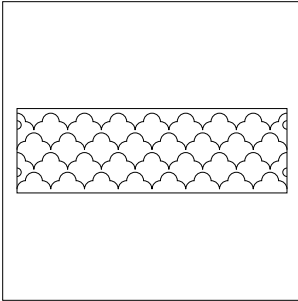

Clamshell - Scallop #1
Single Row Size - 1.5" x 24"

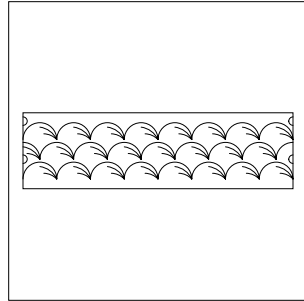

Clamshell with Flair #1
Single Row Size - 1.5" x 24"

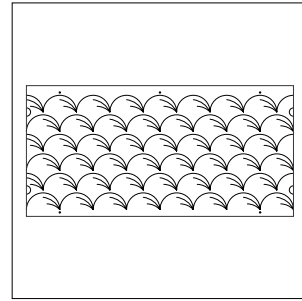

Clamshell with Flair #2
Single Row Size - 1.5" x 24"

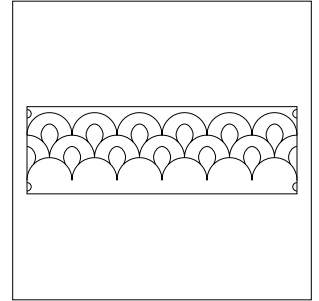

Clamshell with Teardrop #1
Single Row Size - 2.5" x 24"

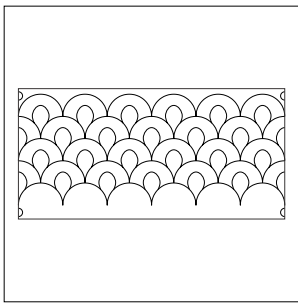

Clamshell with Teardrop #2
Single Row Size - 2.5" x 24"

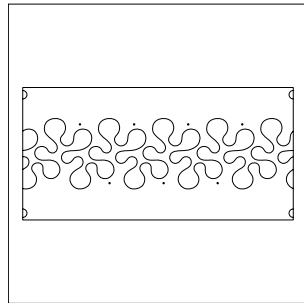

Classic Stipple
Design Size - 6.25" x 24"

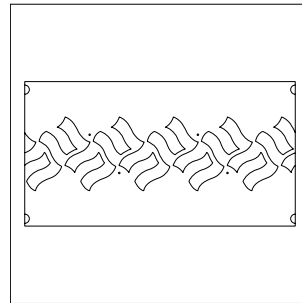

Classic Weave
Design Size - 6" x 22"

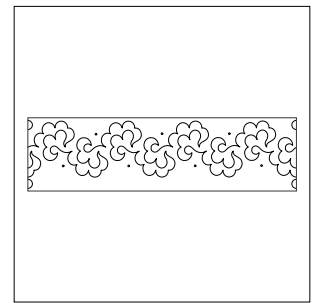

Cloud Nine - Petite
Design Size - 4.5" x 22"

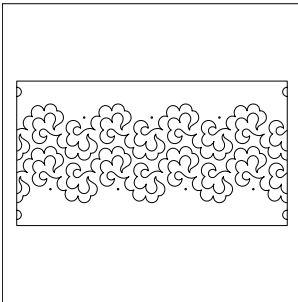

Cloud Nine - Petite - Double Row
Single Row Size - 4.5" x 22"

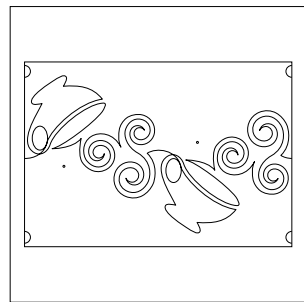

Coffee Break - Set
Set Size - 10" x 34"

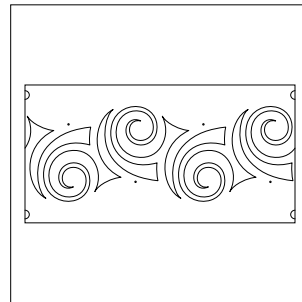

Coil
Design Size - 8.25" x 23.5"

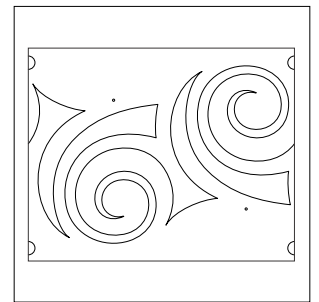

Coil - Grande - Set
Set Size - 10" x 30"

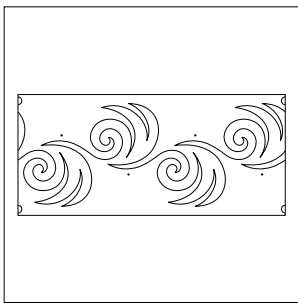

Comb Over
Design Size - 10" x 26"

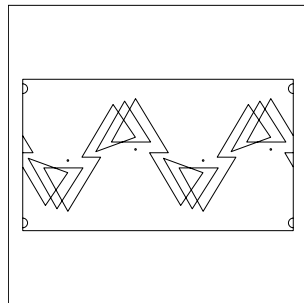

Configuration
Design Size - 8.75" x 21"

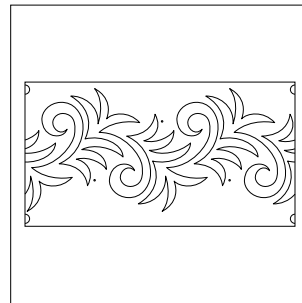

Conifer
Design Size - 10" x 22"

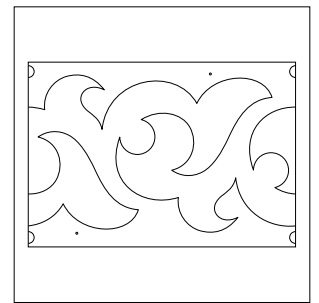

Constance - Set
Set Size - 10" x 34"

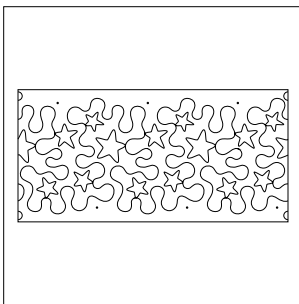

Constellation
Design Size - 10.25" x 24"
© Patricia E. Ritter

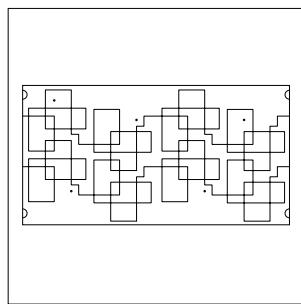

Contempo
Single Row Size - 6.75" x 22.5"
© Hermione Agee

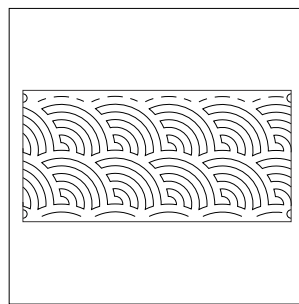

Continuous Baptist Fans
Single Row Size - 4.5" x 24"
© Hermione Agee

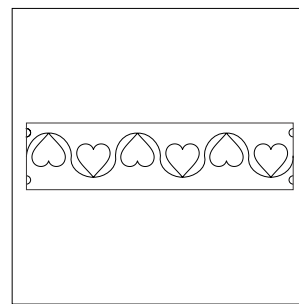

Continuous Hearts
Design Size - 4" x 24"
© R&S Designs

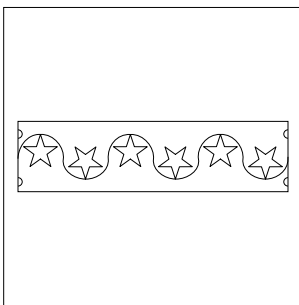

Continuous Stars #1
Design Size - 4" x 24"
© R&S Designs

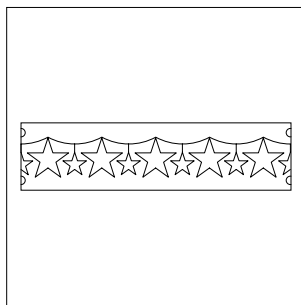

Continuous Stars #2
Design Size - 3.5" x 24"
© R&S Designs

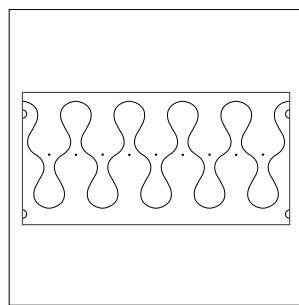

Convex
Design Size - 9.5" x 23.75"
© Megan Hahn

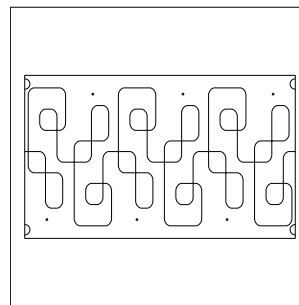

Cool Beans
Design Size - 10" x 19.5"
© Apricot Moon Designs

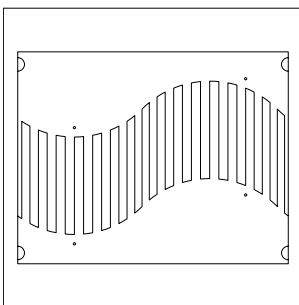

Corrugation #1 - Set
Set Size - 8.5" x 30"
© Patricia E. Ritter & Jessica Schick

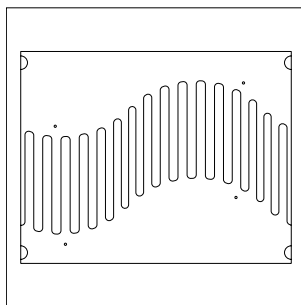

Corrugation #1 - Bias Cut - Set
Set Size - 8.5" x 30"
© Patricia E. Ritter & Jessica Schick

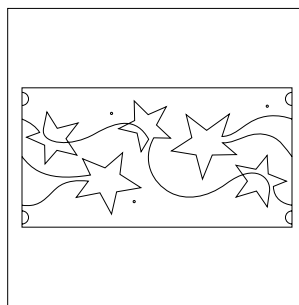

Cosmic - Set
Set Size - 6.5" x 31"
© Jessica Schick

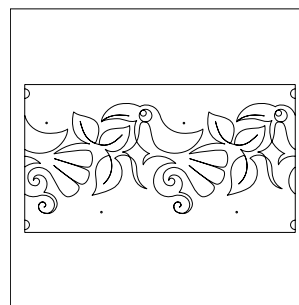

Costa Rica
Design Size - 8.75" x 21.5"
© Melonie J. Caldwell & Sarah Ann Myers

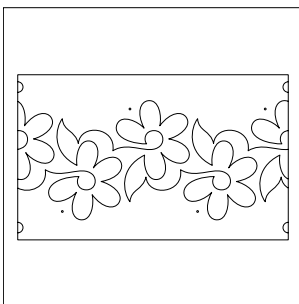

Cottage Garden
Design Size - 8.5" x 19.25"
© Hermione Agee

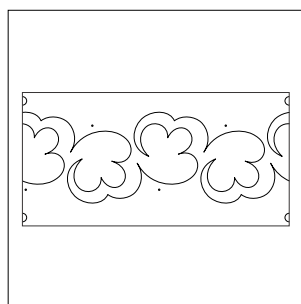

Cottonseed
Design Size - 8" x 23.5"
© Sarah Ann Myers

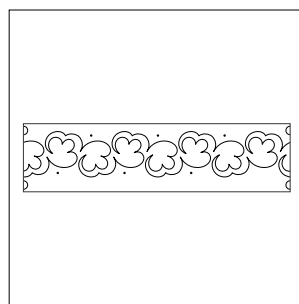

Cottonseed - Petite - 1 Row
Design Size - 4" x 23.5"
© Sarah Ann Myers

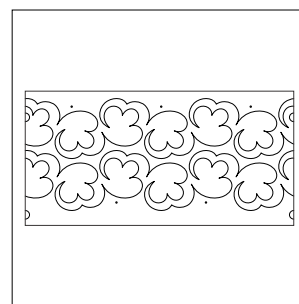

Cottonseed - Petite - 2 Row
Single Row Size - 5.25" x 23.5"
© Sarah Ann Myers

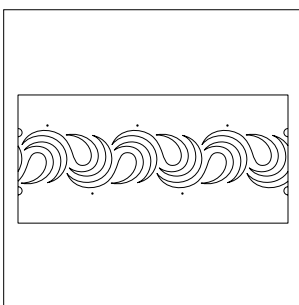

Cove
Design Size - 5.25" x 24.75"
© Patricia E. Ritter & Quilters Apothecary

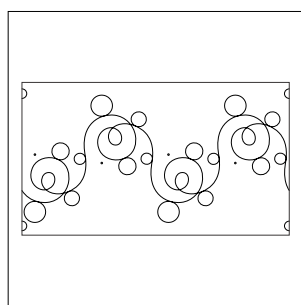

Crazy Eights
Design Size - 10" x 21"
© Sarah Ann Myers

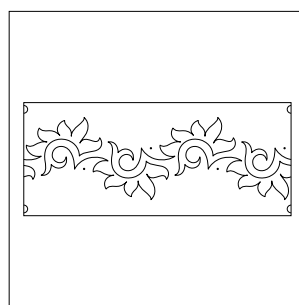

Crazy Little Thing
Design Size - 8" x 26"
© Patricia E. Ritter

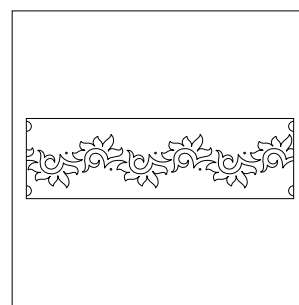

Crazy Little Thing - Petite
Design Size - 4" x 20"
© Patricia E. Ritter

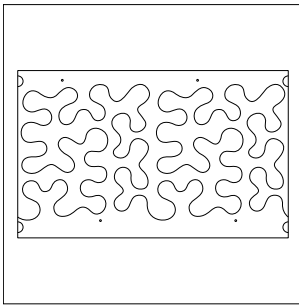

Crazy Puzzle
Design Size - 9.5" x 19"
© Dave Hudson

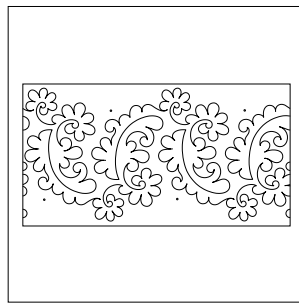

Crepe Myrtle
Design Size - 12" x 24"
© Patricia E. Ritter

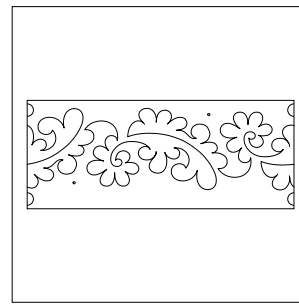

Crepe Myrtle - Petite
Design Size - 5" x 16"
© Patricia E. Ritter

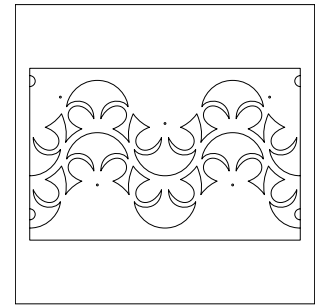

Crescent Curl
Single Row Size - 6.5" x 18.5"
© Hermione Agee

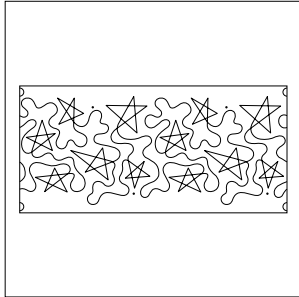

Criss - Cross Stars
Design Size - 10" x 24.75"
© Dave Hudson

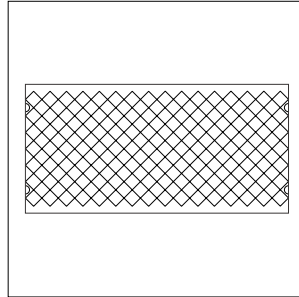

Cross Hatch #1
Design Size - 10.5" x 24"
© R&S Designs

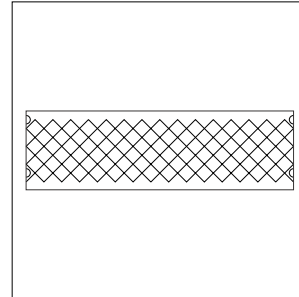

Cross Hatch #2
Design Size - 5.5" x 23.75"
© R&S Designs

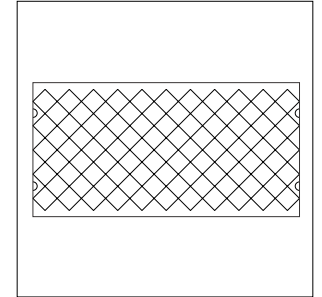

Cross Hatch #3
Design Size - 10.75" x 23.5"
© R&S Designs

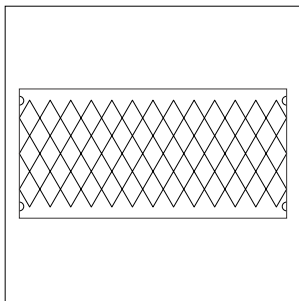

Cross Hatch - Diamonds
Design Size - 9" x 22.75"
© R&S Designs

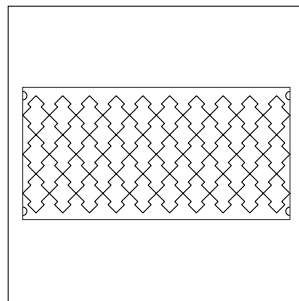

Cross Hatch - Zig Zag
Design Size - 10.5" x 23.75"
© R&S Designs

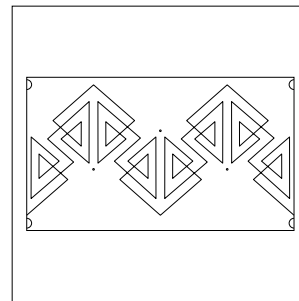

Crossbow
Design Size - 10" x 20.5"
© Sarah Ann Myers

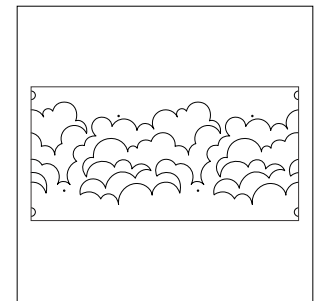

Cumulus
Design Size - 9" x 23.5"
© Jessica Schick

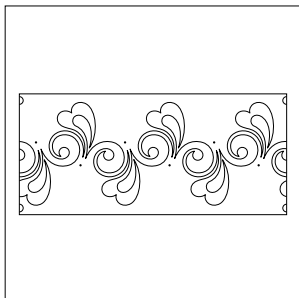

Cupid
Design Size - 10" x 26"
© Patricia E. Ritter & Leisha Farnsworth

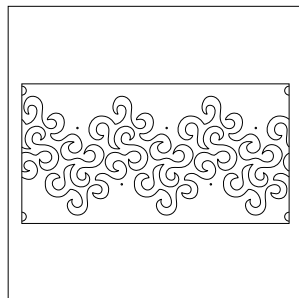

Curlique
Design Size - 10" x 22.5"
© Barbara Becker

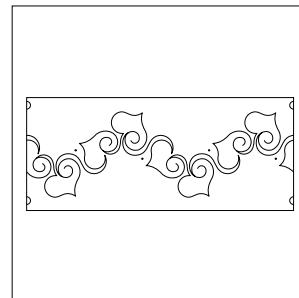

Curly Hearts
Design Size - 8.25" x 26"
© Hermione Agee

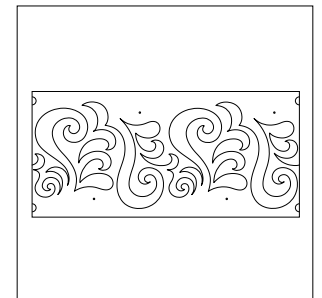

Curly Q
Design Size - 10" x 25"
© Lisa H. Calle

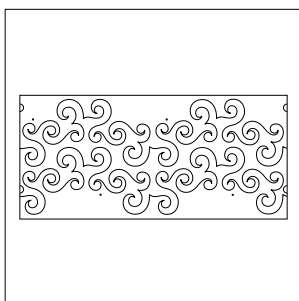

Curlz
Single Row Size - 6.75" x 27"
© Patricia E. Ritter

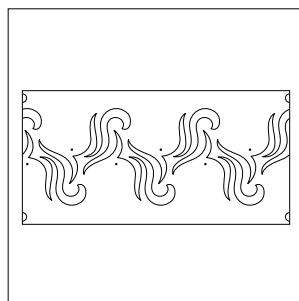

Curry
Design Size - 8.5" x 23.5"
© Sarah Ann Myers

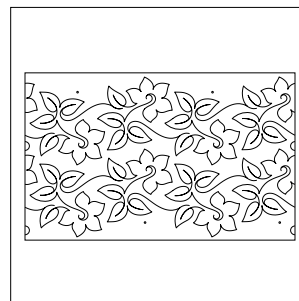

Daffodil
Single Row Size - 7.5" x 23"
© Patricia E. Ritter

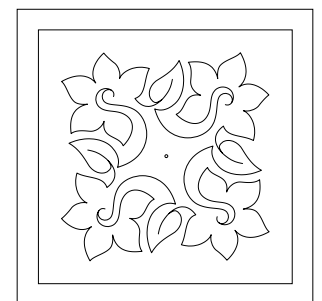

Daffodil - Block #2
Design Size - 9" x 9"
© Patricia E. Ritter

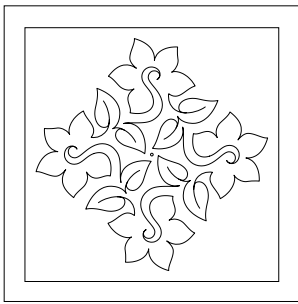

Daffodil - Block #3
Design Size - 10.75" x 10.75"
© Patricia E. Ritter

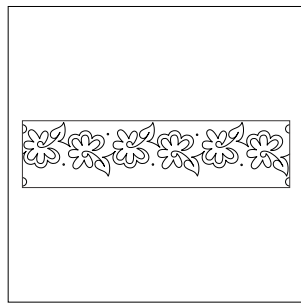

Daisy - Petite
Design Size - 4.75" x 24"
© Patricia E. Ritter

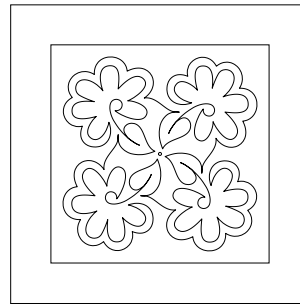

Daisy - Block #2 - Small
Design Size - 8" x 8"
© Patricia E. Ritter

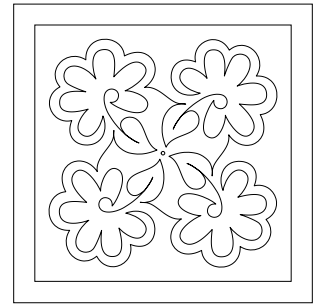

Daisy - Block #2 - Large
Design Size - 10" x 10"
© Patricia E. Ritter

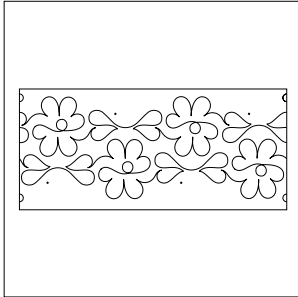

Daisy Chain
Single Row Size - 5.75" x 26"
© Patricia E. Ritter

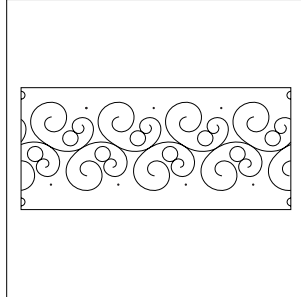

Daisy Doodle - Border
Design Size - 8.5" x 26"
© Patricia E. Ritter

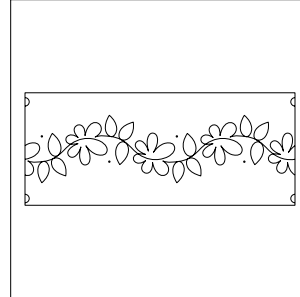

Daisy Dotz #2
Design Size - 6" x 24"
© Patricia E. Ritter

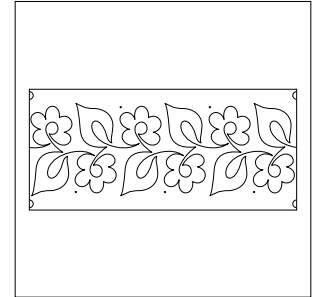

Daisy Duo
Design Size - 9" x 26"
© Dave Hudson

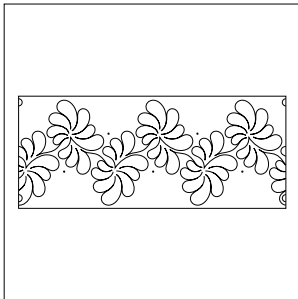

Dandelion
Design Size - 11" x 28"
© Melonie J. Caldwell

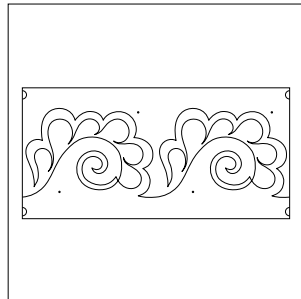

Darlene's Feather
Design Size - 8" x 24"
© Darlene Epp

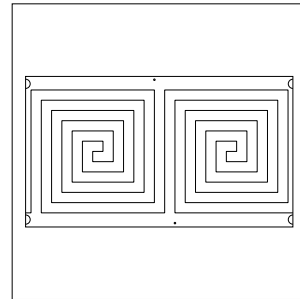

Darlene's Greek Key
Design Size - 10" x 21.75"
© Darlene Epp

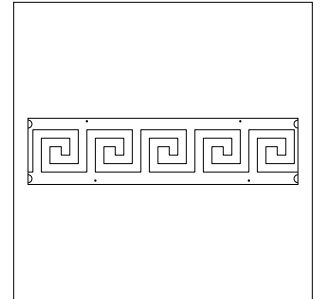

Darlene's Greek Key - Border
Design Size - 4" x 25.5"
© Darlene Epp

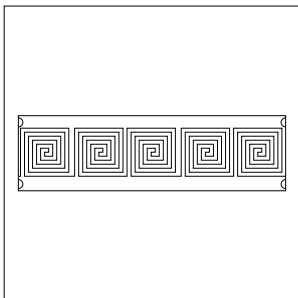

Darlene's Greek Key - Petite
Design Size - 4" x 22.25"
© Darlene Epp

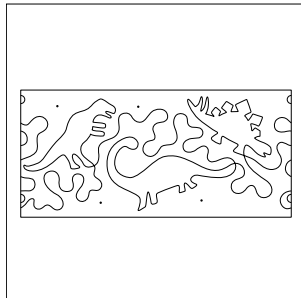

Dave's Dinosaurs
Design Size - 10.5" x 25"
© Dave Hudson

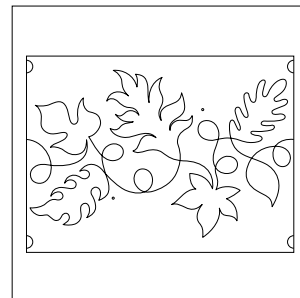

Dave's Falling Leaves - Set
Set Size - 10" x 32"
© Dave Hudson

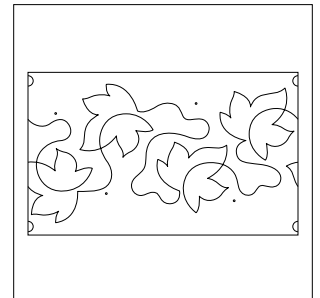

Dave's Maple Leaf
Design Size - 10" x 19.5"
© Dave Hudson

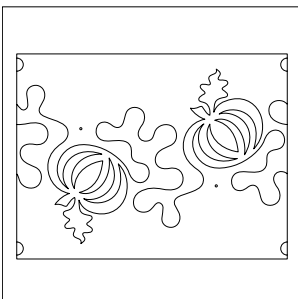

Dave's Pumpkins - Set
Set Size - 10" x 31"
© Dave Hudson

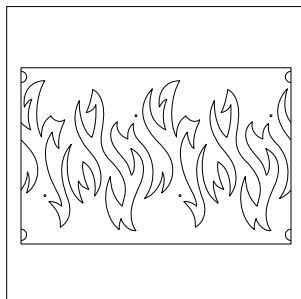

Dave's Tiger Stripes - Set
Set Size - 10" x 36"
© Dave Hudson

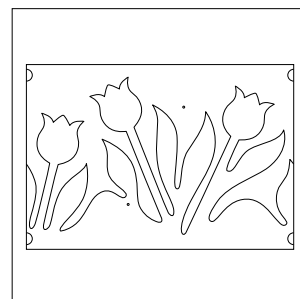

Dave's Tulip Time - Set
Set Size - 10" x 34"
© Dave Hudson

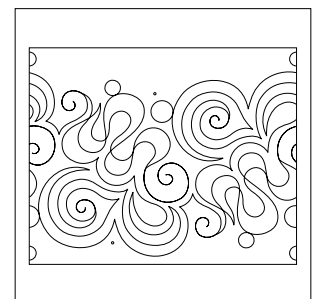

Day Tripper - Set
Set Size - 10" x 29"
© Patricia E. Ritter

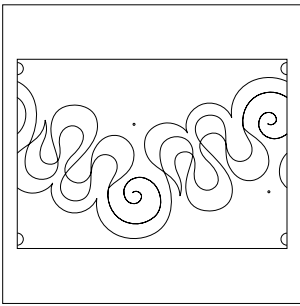

Day Tripper - Border - Set
Set Size - 10" x 33.5"
© Patricia E. Ritter

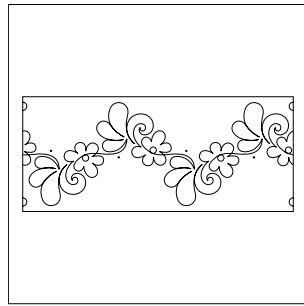

Daydream
Design Size - 9.5" x 24.75"
© Melonie J. Caldwell

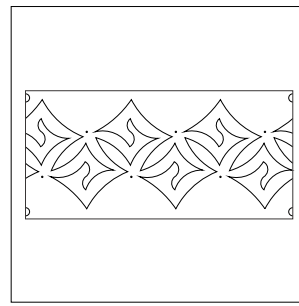

Dazzle
Design Size - 10" x 24.5"
© Hermione Agee

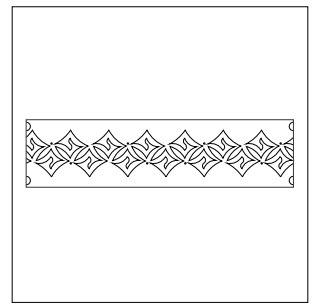

Dazzle - Petite
Design Size - 4.25" x 23.75"
© Hermione Agee

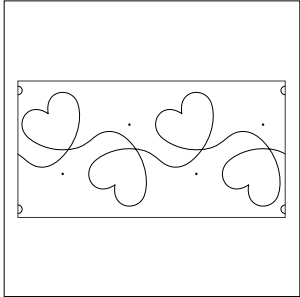

Dear Heart
Design Size - 10" x 23.5"
© Hermione Agee

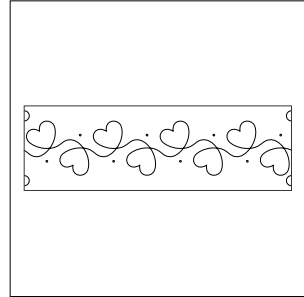

Dear Heart - Petite
Design Size - 4" x 19.75"
© Hermione Agee

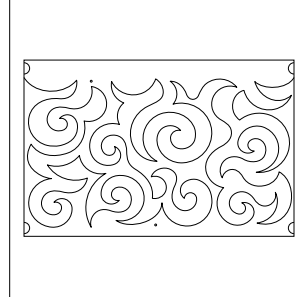

Deb's Swirls - Set
Set Size - 10" x 36"
© Deb Geissler

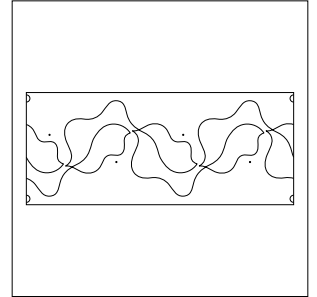

Deciduous
Design Size - 10" x 28"
© Hermione Agee

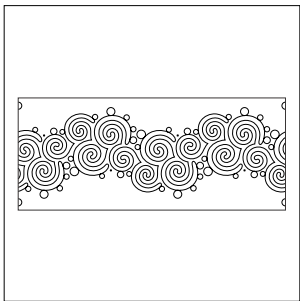

Deep Blue Sea
Design Size - 9.5" x 28"
© Patricia E. Ritter

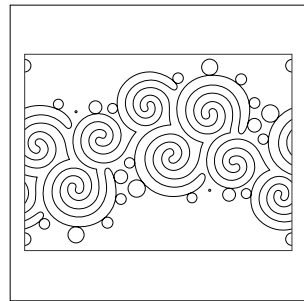

Deep Blue Sea - Grande - Set
Set Size - 11" x 32"
© Patricia E. Ritter

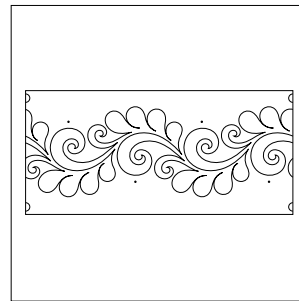

Deja Vu
Design Size - 8" x 23.75"
© Patricia E. Ritter & Valerie Smith

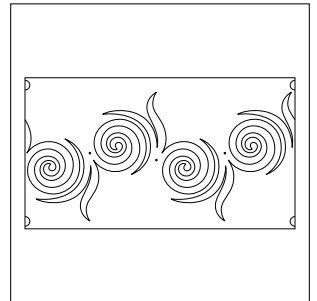

Denise's Spinners
Design Size - 10" x 21"
© Patricia E. Ritter & Denise Schillinger

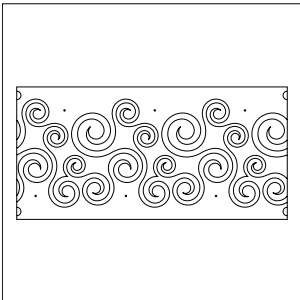

Denise's Spirals
Design Size - 9.5" x 24"
© Denise Schillinger

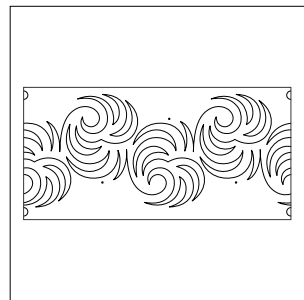

Desert Thistle
Design Size - 10" x 23.75"
© Sarah Ann Myers

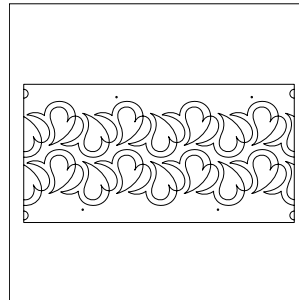

Devotion
Single Row Size - 4.75" x 23"
© Hermione Agee

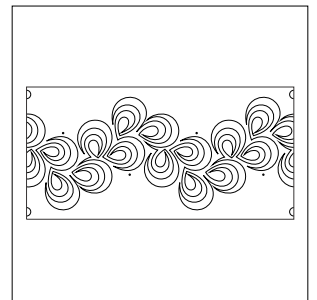

Dewdrops
Design Size - 10" x 23.75"
© Patricia E. Ritter

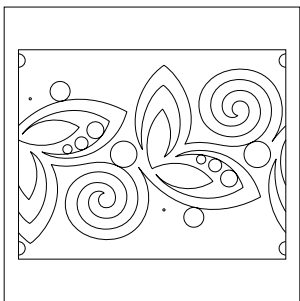

Dewdrops in the Garden - Set
Set Size - 10" x 30"
© Patricia E. Ritter

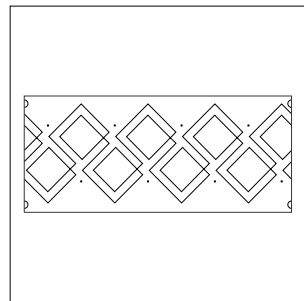

Diagonal Plaid
Design Size - 10" x 27"
© Patricia E. Ritter

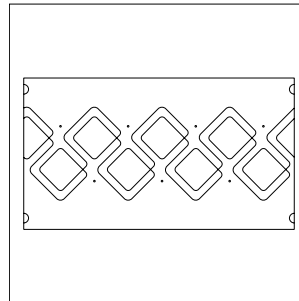

Diagonal Plaid - Bias Cut
Design Size - 7.25" x 21"
© Patricia E. Ritter

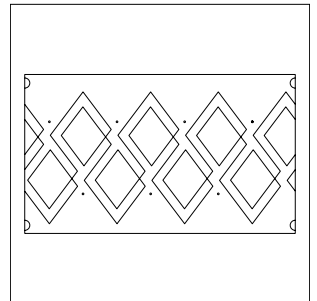

Diagonal Plaid - Diamond Cut
Design Size - 9.75" x 20"
© Patricia E. Ritter

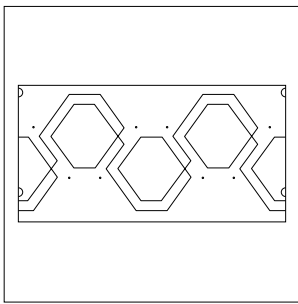

Diagonal Plaid - Hexies
Design Size - 10" x 23"

© Patricia E. Ritter & Leisha Farnsworth

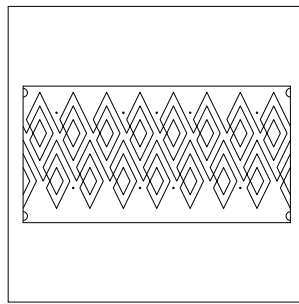

Diamond Squared
Design Size - 10" x 23"

© Leisha Farnsworth

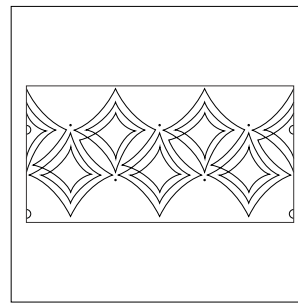

Diamonds Are Forever
Design Size - 11" x 23"

© Patricia E. Ritter

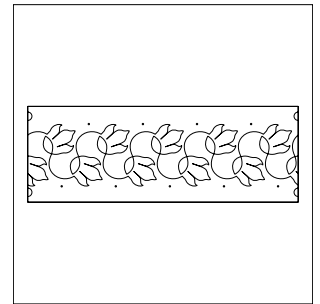

Dino Prints
Design Size - 5.5" x 24"

© Timeless Quilting Designs

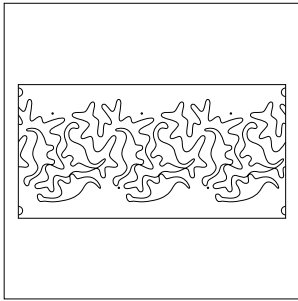

Dino Swamp
Design Size - 9" x 23.5"

© Apricot Moon Designs

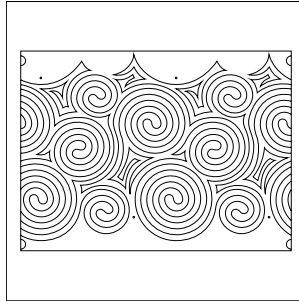

Dizzy Izzy
Design Size - 14.5" x 21"

© Jessica Schick

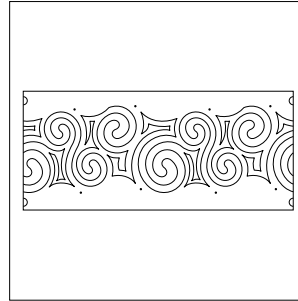

Dizzy Izzy Baby
Design Size - 8" x 25"

© Jessica Schick

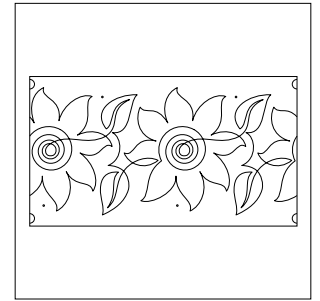

Dizzy Sunflower
Design Size - 10" x 21"

© Ashley Schick

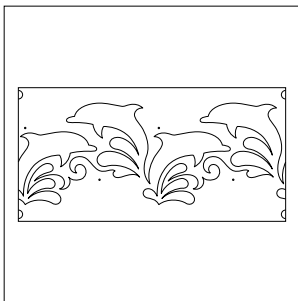

Dolphin Dance
Design Size - 9" x 23.5"

© Hermione Agee

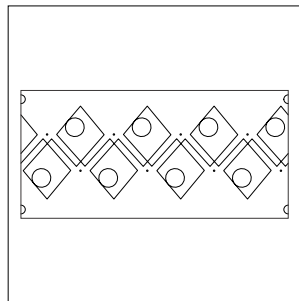

Dominos
Design Size - 8" x 23"

© Patricia E. Ritter

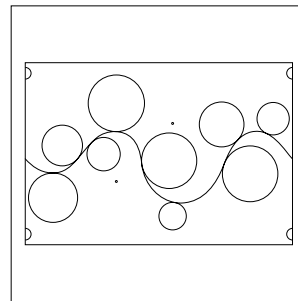

Double Bubble #2 - Grande - Set
Set Size - 10" x 34.5"

© Patricia E. Ritter

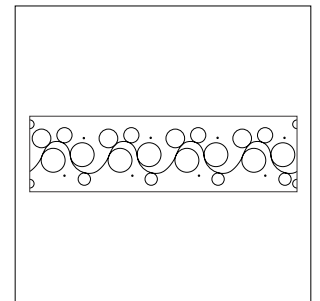

Double Bubble #2 - Petite - 1 Row
Design Size - 5" x 23"

© Patricia E. Ritter

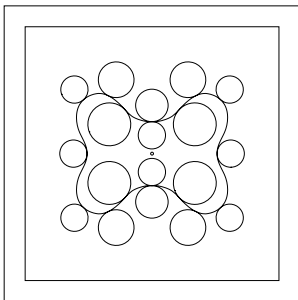

Double Bubble #2 - Block
Design Size - 8" x 8"

© Patricia E. Ritter

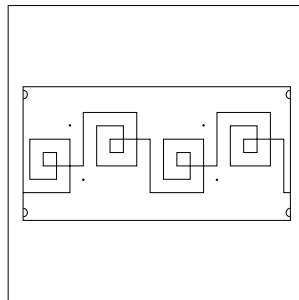

Double Squared
Design Size - 7" x 23.5"

© Leisha Farnsworth

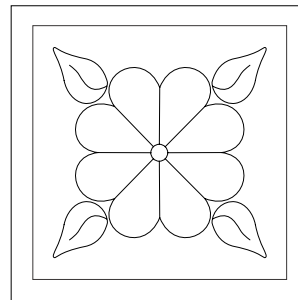

Double Wedding Ring - Block
Design Size - 8.25" x 8.25"

© R&S Designs

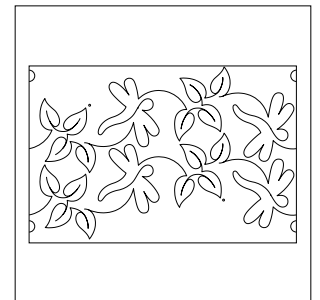

Dragonflies - Set
Single Row Size - 7" x 17.75"

© Patricia E. Ritter

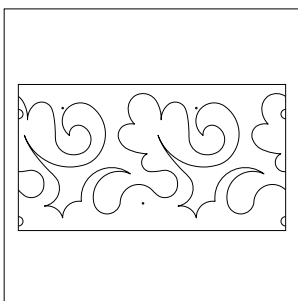

Drift
Design Size - 10" x 21.5"

© Keryn Emmerson

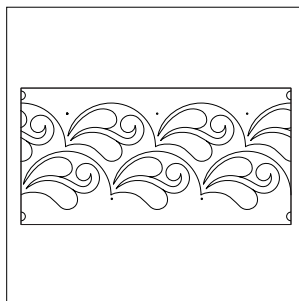

Drifting Clamshells #1
Single Row Size - 5" x 23.25"

© Naomi Hynes

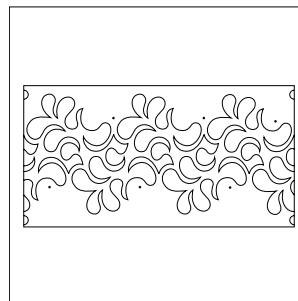

Drunken Feathers
Design Size - 10" x 22.5"

© Barbara Becker

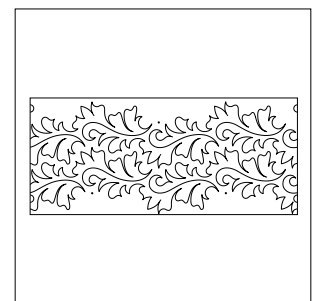

Dusty Miller
Single Row Size - 6.75" x 27.5"

© Patricia E. Ritter

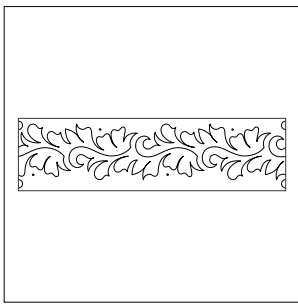

Dusty Miller - Petite
Design Size - 5" x 24"
© Patricia E. Ritter

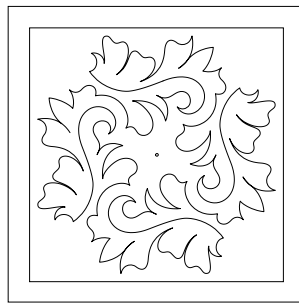

Dusty Miller - Block #1
Design Size - 11" x 11"
© Patricia E. Ritter

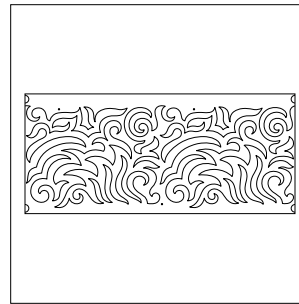

Earth, Wind and Fire
Design Size - 10" x 26.5"
© Darlene Epp

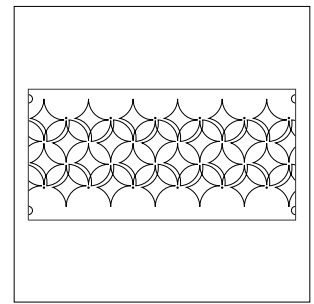

Easy Orange Peel
Single Row Size - 5.75" x 24"
© Patricia E. Ritter

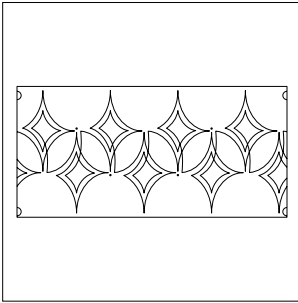

Easy Orange Peel - Unfurled
Design Size - 11" x 24.25"
© Patricia E. Ritter & Marybeth O'Halloran

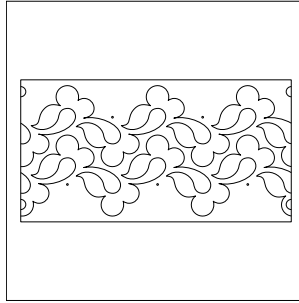

Easy Peasy
Single Row Size - 6" x 20"
© Hermione Agee

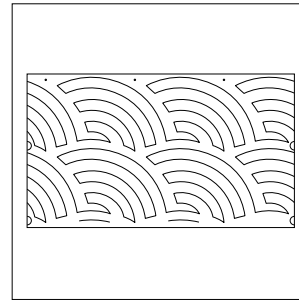

Easy Peasy Baptist Fan
Single Row Size - 6.5" x 23.5"
© Naomi Hynes

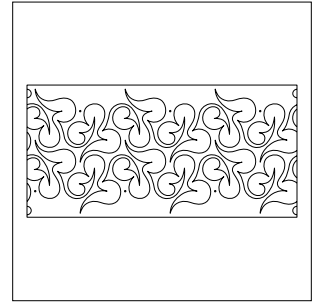

Easy Street
Single Row Size - 6.5" x 24"
© Lisa H. Calle

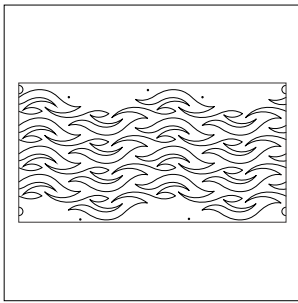

Ebb & Flow
Single Row Size - 4" x 24"
© Hermione Agee

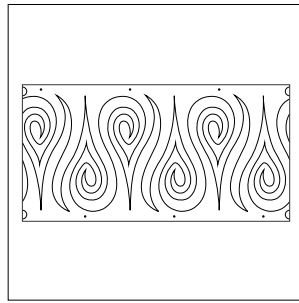

Echo of Light
Design Size - 10" x 23"
© Mary Eddy / Jelly Bean

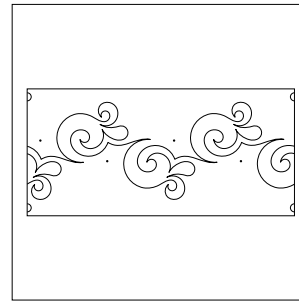

Effervescence
Design Size - 9" x 24.75"
© Hermione Agee

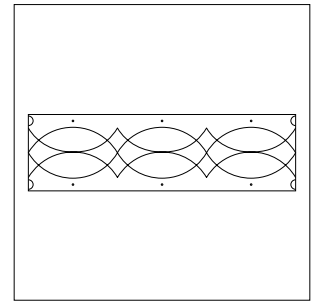

Egg and Dart #1
Design Size - 4" x 21"
© Kim Brunner

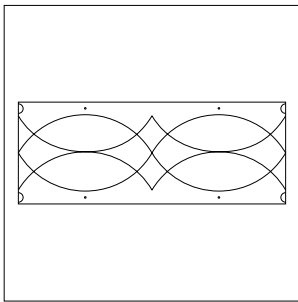

Egg and Dart #2
Design Size - 6" x 21"
© Kim Brunner

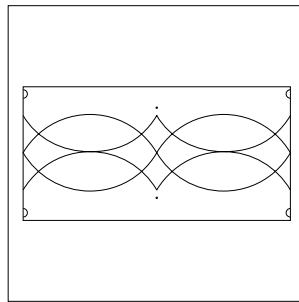

Egg and Dart #3
Design Size - 6.75" x 23.5"
© Kim Brunner

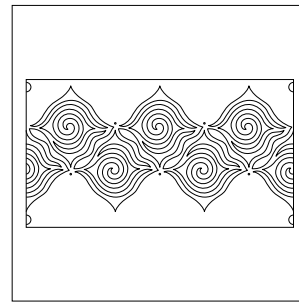

Elemental
Design Size - 10" x 21.25"
© Naomi Hynes

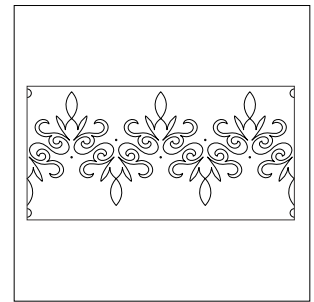

Elfe
Design Size - 10" x 23.5"
© Claudia Pfeil

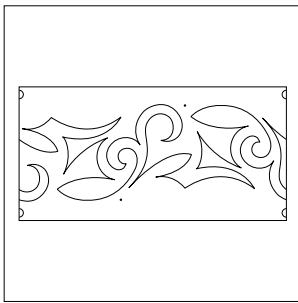

Elfe - Border
Design Size - 8.5" x 23.5"
© Claudia Pfeil

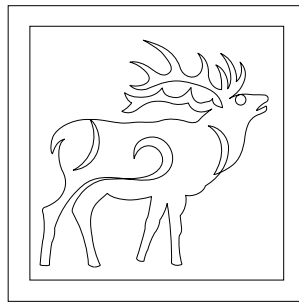

Elk - Motif
Design Size - 10.5" x 10.5"
© Deb Geissler

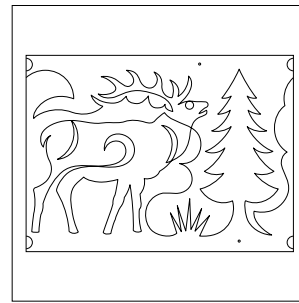

Elk and Pines - Border - Set
Set Size - 10" x 32"
© Deb Geissler

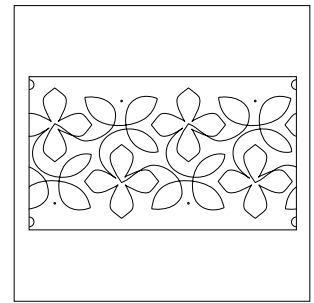

Elkweed
Design Size - 10" x 20.5"
© Apricot Moon Designs

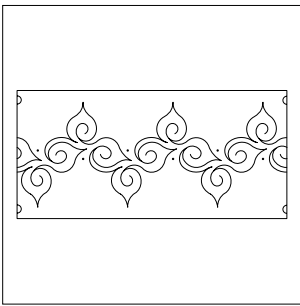

Entangle
Design Size - 9.5" x 24.75"
© Hermione Agee

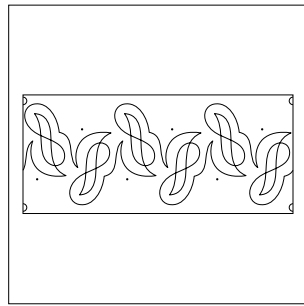

Ether
Design Size - 10" x 26.75"
© Hermione Agee

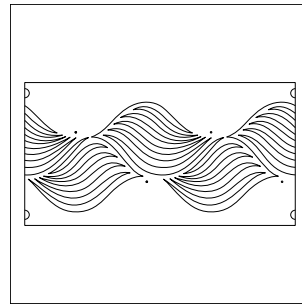

Euphoria
Design Size - 9" x 22.25"
© Patricia E. Ritter

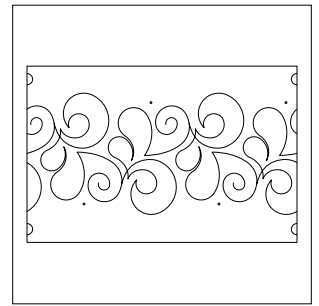

Exquisite
Design Size - 8" x 18"
© Hermione Agee

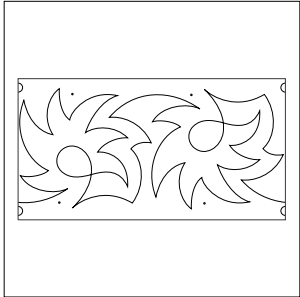

Eye of the Storm
Design Size - 10" x 22.25"
© Patricia E. Ritter

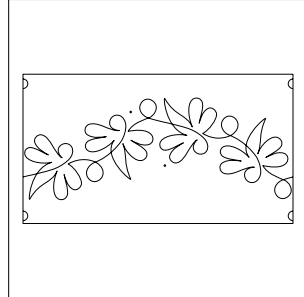

EZ Dragonflies
Design Size - 8" x 21.25"
© Patricia E. Ritter

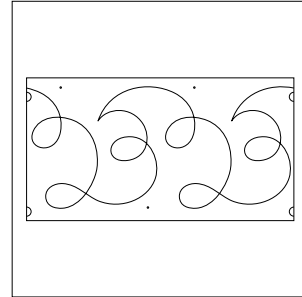

EZ Loops
Design Size - 10" x 22"
© Dave Hudson

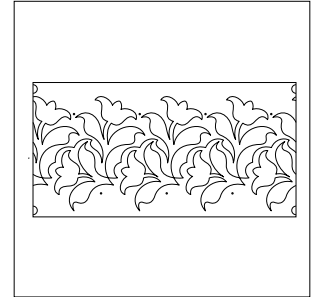

EZ Tulips
Design Size - 10" x 23"
© Jessica Schick

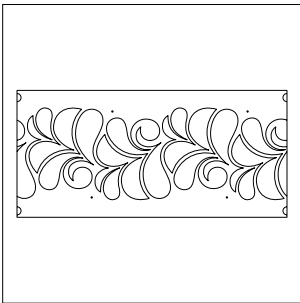

Fable
Design Size - 8.5" x 25"
© OESD & Jeffery Schillinger

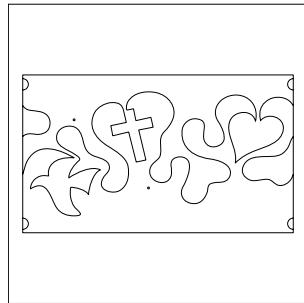

Faith, Hope and Love
Design Size - 8.25" x 18"
© Dave Hudson

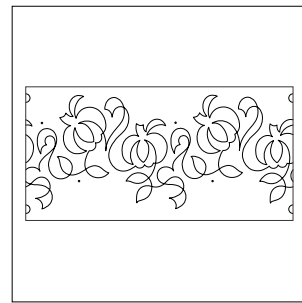

Fall Reward
Design Size - 10" x 23.5"
© Nancy Read

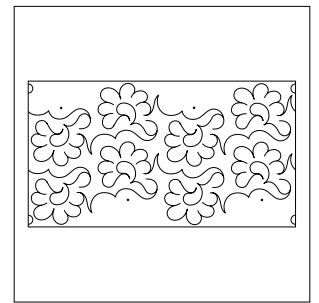

Fan Palm
Single Row Size - 6.75" x 22"
© Patricia E. Ritter

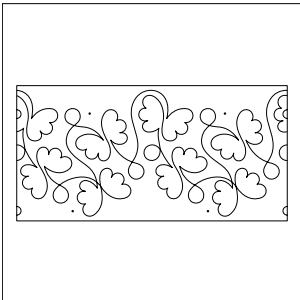

Fanciful Flyers
Design Size - 11" x 23.5"
© Jessica Schick

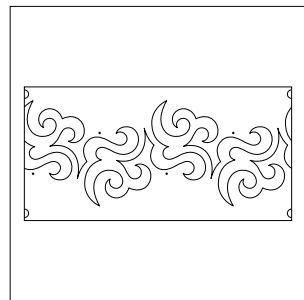

Fancy Free
Design Size - 9.25" x 23.5"
© Sarah Ann Myers

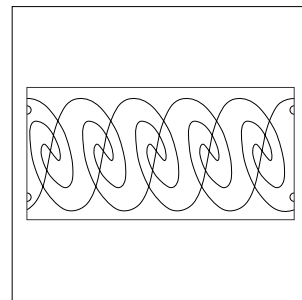

Fancy Spiral
Design Size - 10" x 23.75"
© R&S Designs

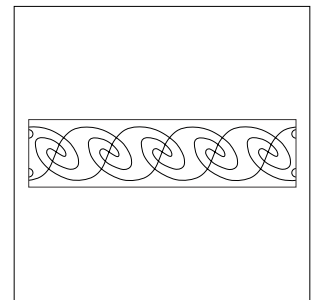

Fancy Spiral - Petite
Design Size - 4.75" x 23.75"
© R&S Designs

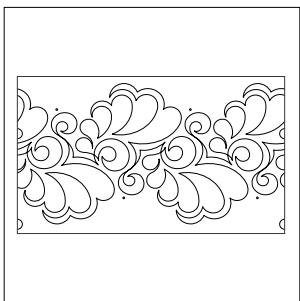

Fantasia
Design Size - 10.5" x 20"
© Hermione Agee

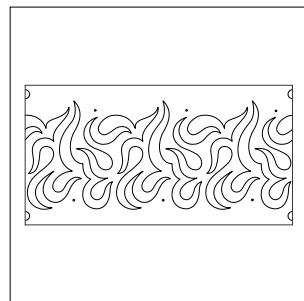

Fantasy Flame
Design Size - 9.25" x 22.5"
© Jessica Schick

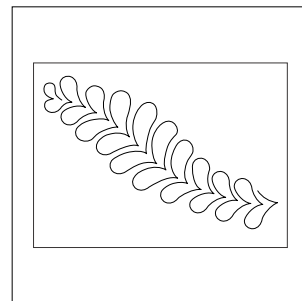

Feather - Single - Motif
Design Size - 10.25" x 6.5"
© R&S Designs

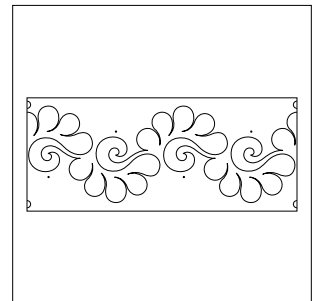

Feather Flip
Design Size - 10" x 28"
© Hermione Agee

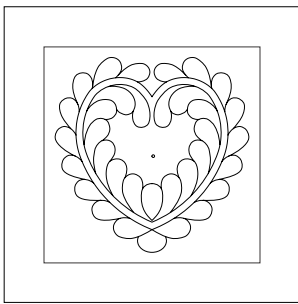

Feather Heart - Block - Small
Design Size - 9" x 9"
© R&S Designs

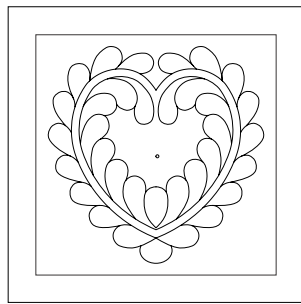

Feather Heart - Block - Medium
Design Size - 11.5" x 11.5"
© R&S Designs

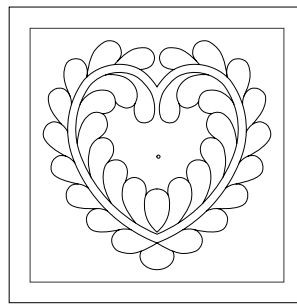

Feather Heart - Block - Large
Design Size - 14" x 14"
© R&S Designs

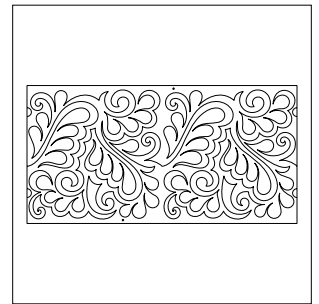

Feather Meander - Boxed Up
Design Size - 11" x 23"
© Jessica Schick

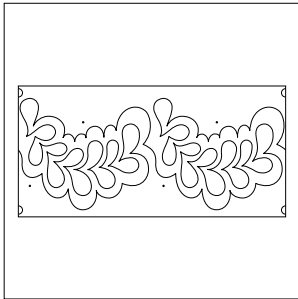

Feather Plume
Design Size - 10" x 24"
© Dave Hudson

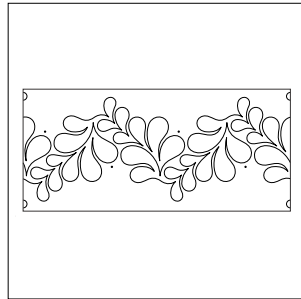

Feather Puff
Design Size - 10" x 25.75"
© Hermione Agee

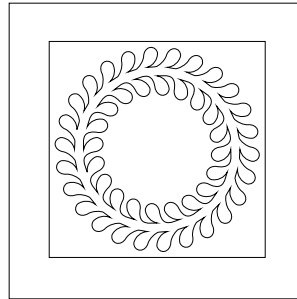

Feather Ring - Block - Small
Design Size - 5" x 5"
© R&S Designs

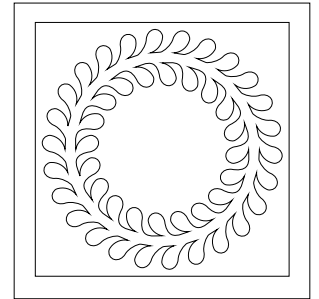

Feather Ring - Block - Large
Design Size - 11" x 11"
© R&S Designs

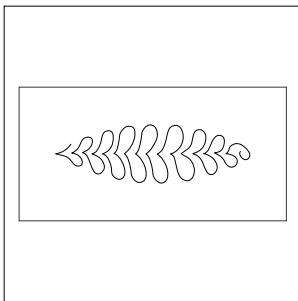

Feather Slice - Motif
Design Size - 5.75" x 1.75"
© R&S Designs

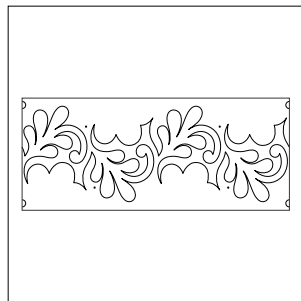

Featherize
Design Size - 10" x 28"
© Hermione Agee

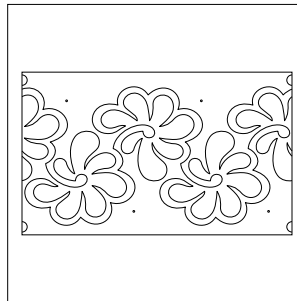

Feathers in Bloom
Design Size - 10" x 19.5"
© Barbara Becker

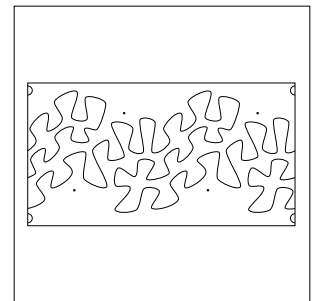

Ferna
Design Size - 10" x 22"
© Apricot Moon Designs

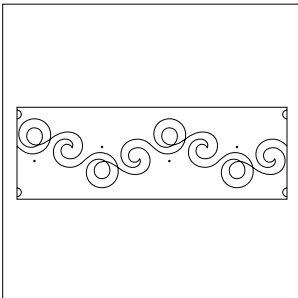

Fiesta
Design Size - 6" x 23.5"
© Melonie J. Caldwell

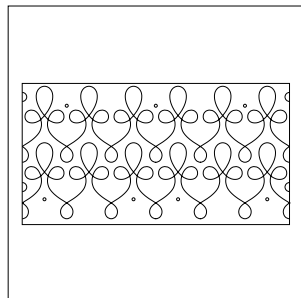

Filigree
Single Row Size - 6.25" x 22.25"
© Patricia E. Ritter

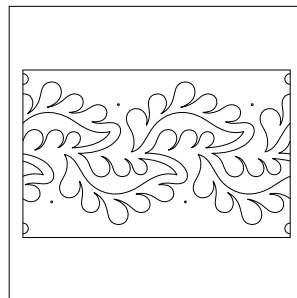

Finer - Set
Set Size - 10" x 37.5"
© Hermione Agee

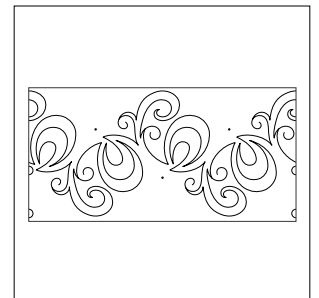

Finesse
Design Size - 11" x 23.5"
© Hermione Agee

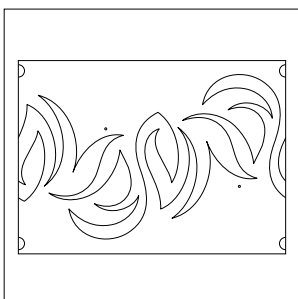

Fire and Ice - Set
Set Size - 10" x 32.5"
© Sarah Ann Myers

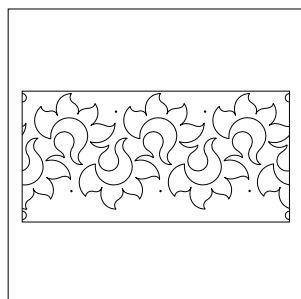

Fire Flower
Design Size - 10.5" x 24"
© Hermione Agee

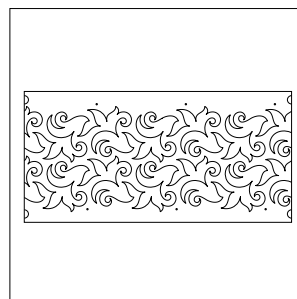

Fire Lily
Single Row Size - 5" x 20"
© Patricia E. Ritter

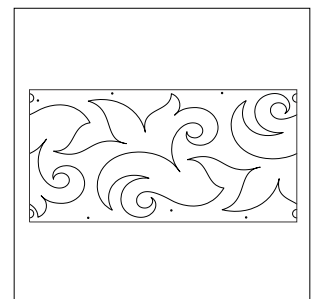

Fire Lily - Grande
Design Size - 11" x 23.75"
© Patricia E. Ritter

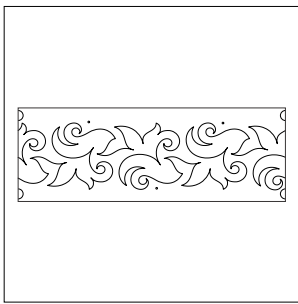

Fire Lily - Petite
Design Size - 5" x 20"
© Patricia E. Ritter

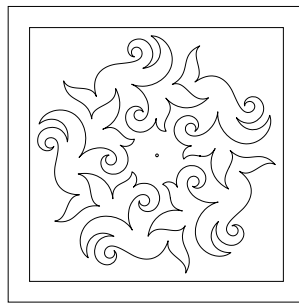

Fire Lily - Block
Design Size - 11" x 11"
© Patricia E. Ritter

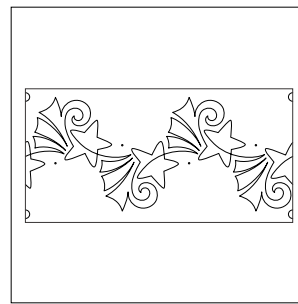

Fireworks
Design Size - 10" x 23.5"
© Melonie J. Caldwell

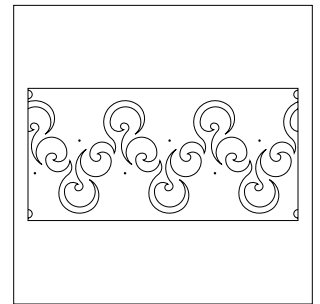

Fizz
Design Size - 10" x 24"
© Hermione Agee

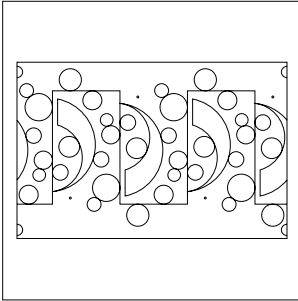

Fizzle - Set
Set Size - 10.5" x 36"
© Melonie J. Caldwell

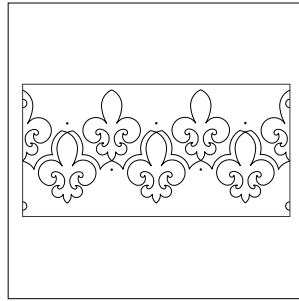

Fleur
Design Size - 10" x 23.75"
© Hermione Agee

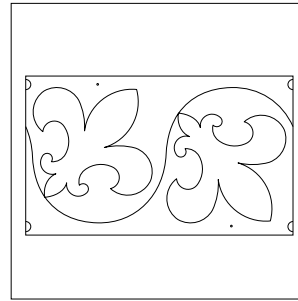

Fleur De Lis Shield - Border
Design Size - 10" x 19.75"
© Deb Geissler

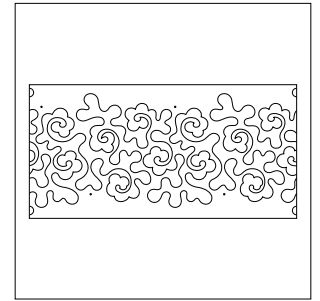

Floral Meander
Design Size - 10" x 23.5"
© Dave Hudson

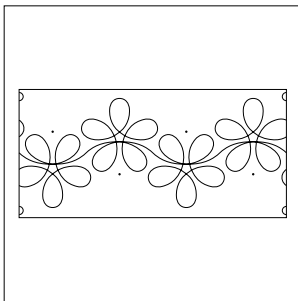

Flower Child
Design Size - 10" x 24.5"
© Apricot Moon Designs

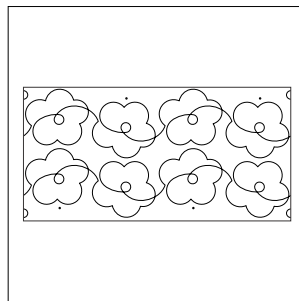

Flower Puff
Single Row Size - 6" x 23.5"
© Hermione Agee

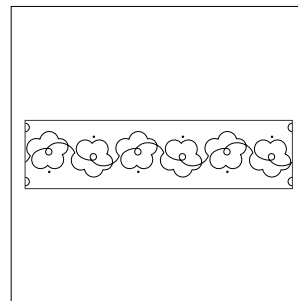

Flower Puff - Petite
Design Size - 4" x 23.5"
© Hermione Agee

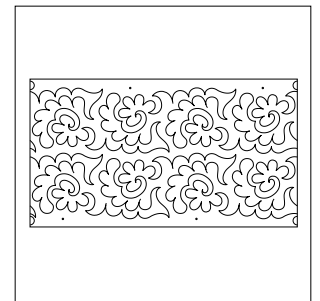

Flowers and Fronds
Single Row Size - 5.75" x 23.5"
© Patricia E. Ritter

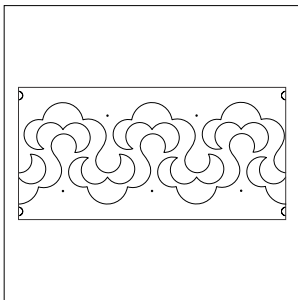

Fluffy
Design Size - 9" x 23.75"
© Hermione Agee

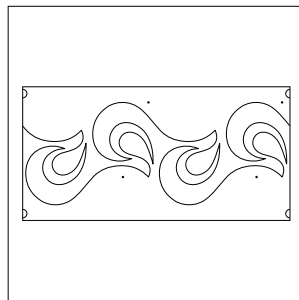

Fluidity
Design Size - 9" x 23.5"
© Sarah Ann Myers

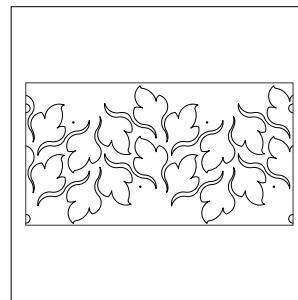

Flutter Leaves
Single Row Size - 7.5" x 23"
© Hermione Agee

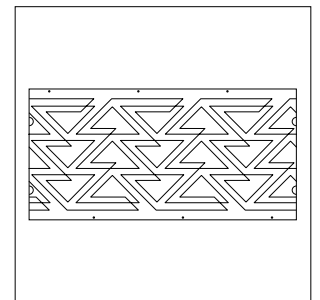

Flyway
Design Size - 10" x 24"
© Melonie J. Caldwell

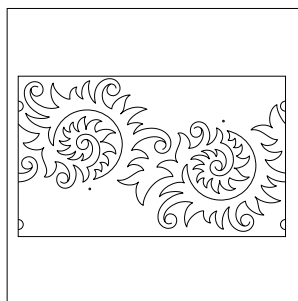

Fossil
Design Size - 11.5" x 20"
© Patricia E. Ritter

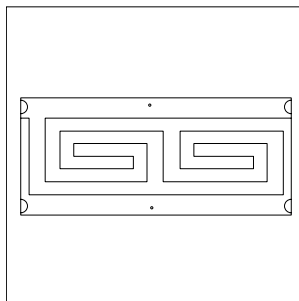

Four Corners - Set
Set Size - 4.25" x 30"
© Patricia E. Ritter

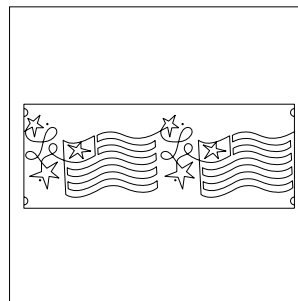

Freedom
Design Size - 8" x 26"
© Nancy Read

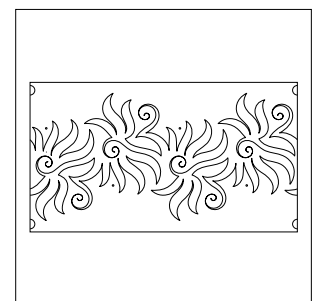

French Quarter
Design Size - 10" x 21"
© Patricia E. Ritter & Melonie J. Caldwell

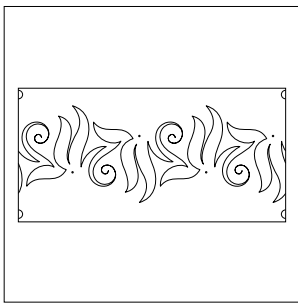

French Quarter - Petite
Design Size - 8.5" x 23.5"

© Patricia E. Ritter & Melonie J. Caldwell

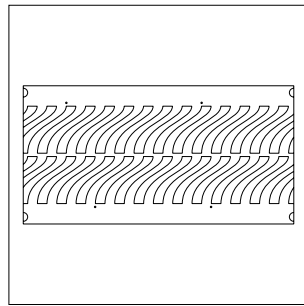

Frequency
Single Row Size - 4" x 23"

© Melissa Kelley

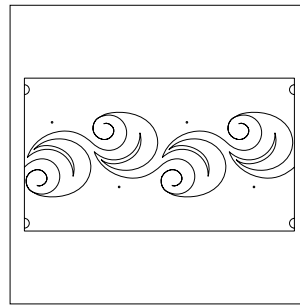

Fresh Air
Design Size - 6.5" x 20.75"

© Patricia E. Ritter & Quilters Apothecary

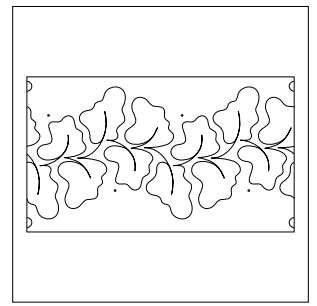

Fresh Chard
Design Size - 10" x 20.25"

© Sarah Ann Myers

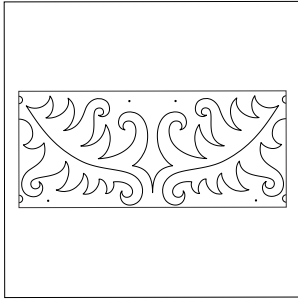

Frollicking Fern
Design Size - 11" x 27.5"

© Lisa H. Calle

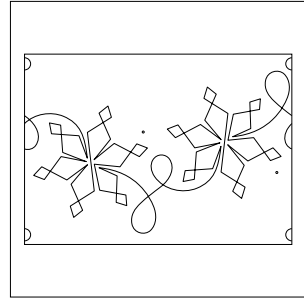

Frost - Set
Set Size - 10" x 33"

© Patricia E. Ritter & Leisha Farnsworth

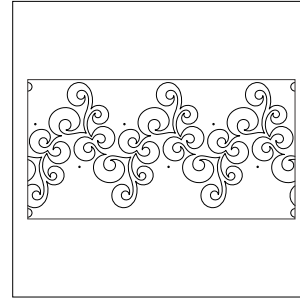

Froth and Bubble
Design Size - 11" x 23.5"

© Hermione Agee

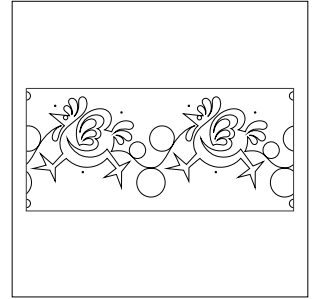

Funky Chicken
Design Size - 9" x 24"

© Patricia E. Ritter

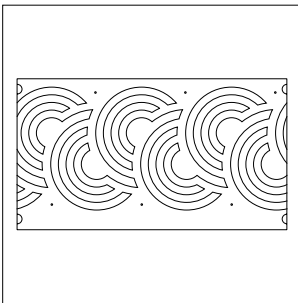

Funky Fans
Design Size - 9.5" x 21"

© Lisa H. Calle

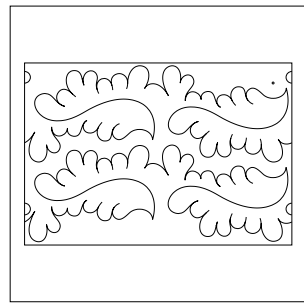

Funky Feathers - Set
Single Row Size - 6.25" x 17.25"

© Patricia E. Ritter

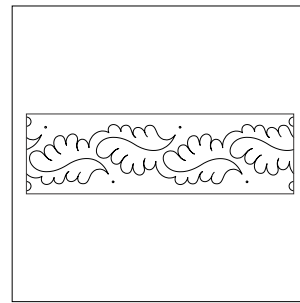

Funky Feathers - Petite
Design Size - 5" x 21.75"

© Patricia E. Ritter

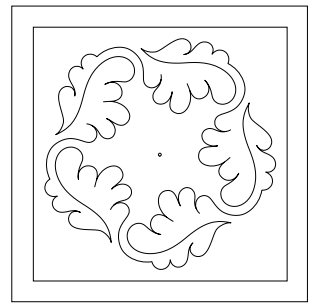

Funky Feathers - Block
Design Size - 10" x 10"

© Patricia E. Ritter

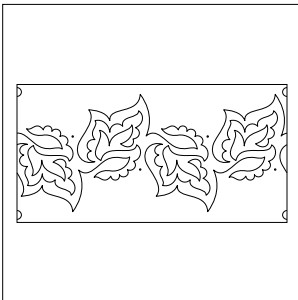

Furnace
Design Size - 10" x 23"

© Hermione Agee

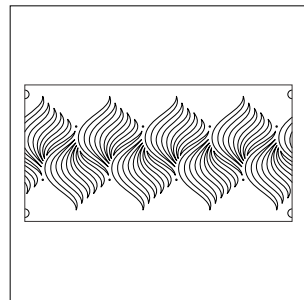

Fusion
Design Size - 10" x 23.5"

© Patricia E. Ritter

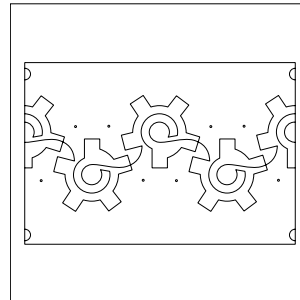

Gadget
Design Size - 7.5" x 17.5"

© Patricia E. Ritter

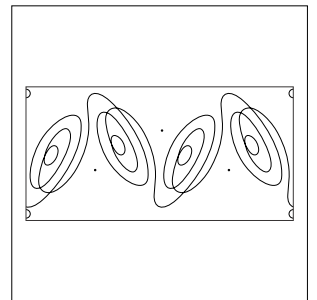

Galaxy
Design Size - 10" x 23.5"

© Sarah Ann Myers

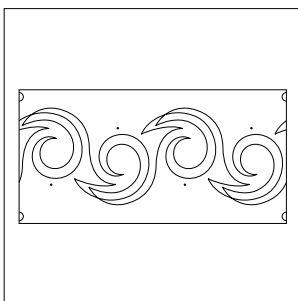

Gale
Design Size - 8.5" x 23.5"

© Sarah Ann Myers

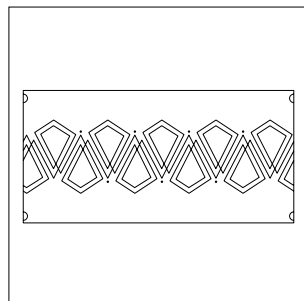

Gambit
Design Size - 6.5" x 24"

© Sarah Ann Myers

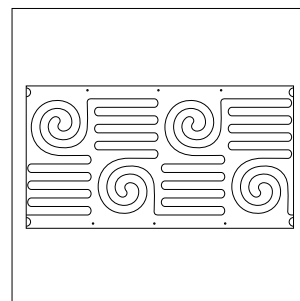

Game Night
Design Size - 10" x 23"

© Patricia E. Ritter

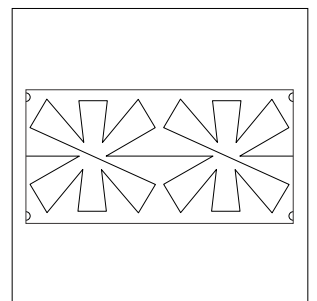

Gamma
Design Size - 10" x 23.5"

© Patricia E. Ritter & Valerie Smith

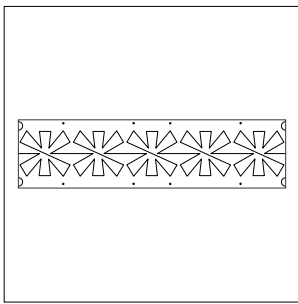

Gamma - Petite
Design Size - 4" x 23.5"

© Patricia E. Ritter & Valerie Smith

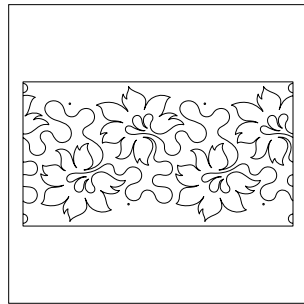

Garden Flower
Design Size - 11" x 22"

© Dave Hudson

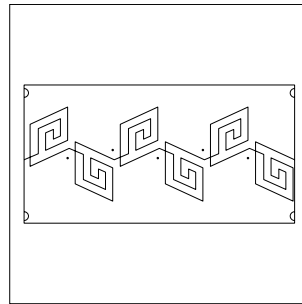

Garden Maze
Design Size - 8" x 23"

© Patricia E. Ritter & Melonie J. Caldwell

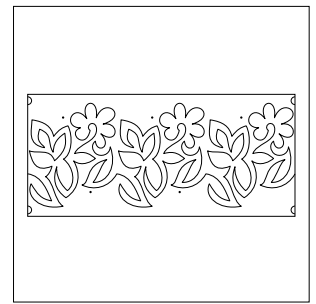

Garden Walk
Design Size - 10" x 25.75"

© Barbara Becker

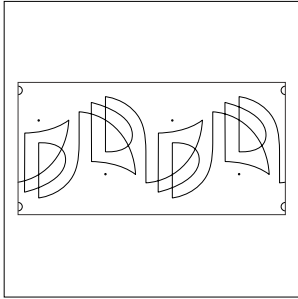

Gatsby
Design Size - 9" x 23.75"

© Sarah Ann Myers

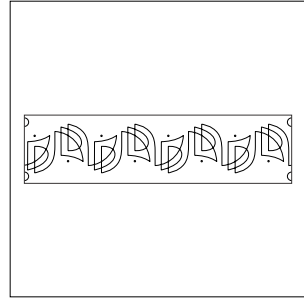

Gatsby - Petite
Design Size - 4.25" x 23.5"

© Sarah Ann Myers

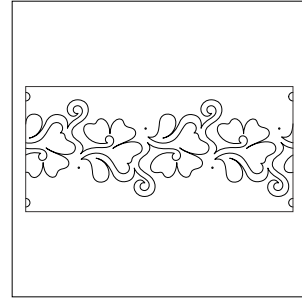

Gazebo
Design Size - 8.5" x 23.5"

© Patricia E. Ritter

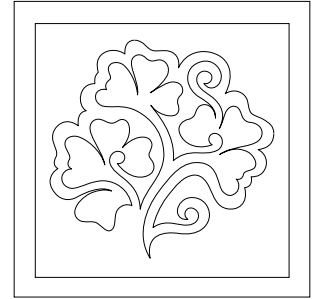

Gazebo - Block #2
Design Size - 11" x 10.75"

© Patricia E. Ritter

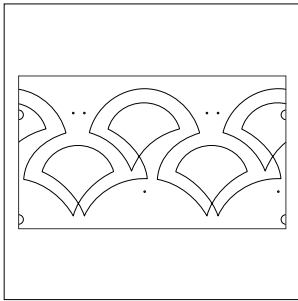

Geisha
Design Size - 10" x 21"

© Melonie J. Caldwell

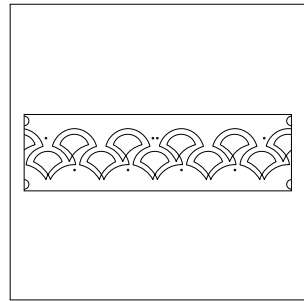

Geisha - Petite
Design Size - 4" x 21"

© Melonie J. Caldwell

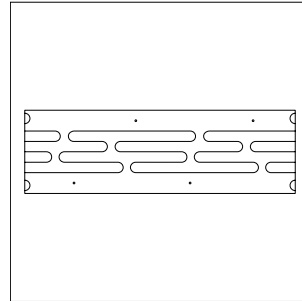

Geoglyphs
Design Size - 3" x 19.5"

© Patricia E. Ritter & Sarah Ann Myer

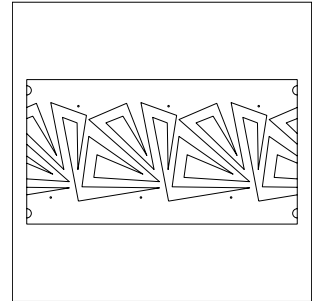

Geometric Lines
Design Size - 8" x 22"

© Jackie's Machine Quilting

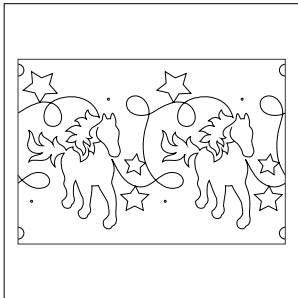

Giddy Up - Set
Set Size - 10" x 34"

© Patricia E. Ritter & OESD

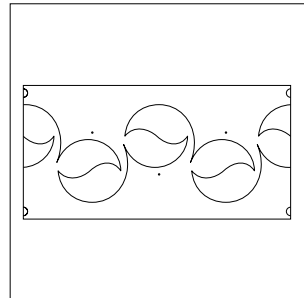

Gigong
Design Size - 8.5" x 23.5"

© Sarah Ann Myers

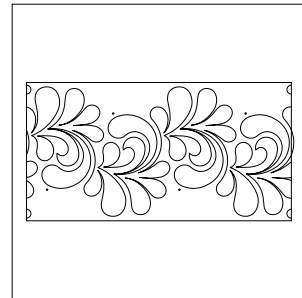

Ginger
Design Size - 11" x 22.5"

© Patricia E. Ritter & Leisha Farnsworth

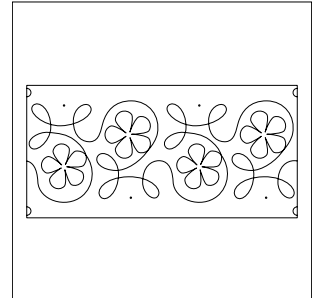

Ginger Flower
Design Size - 9" x 24"

© Apricot Moon Designs

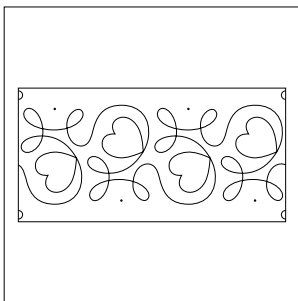

Ginger Heart
Design Size - 8.75" x 23.5"

© Apricot Moon Designs

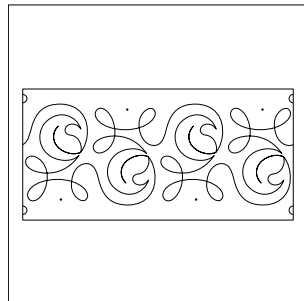

Ginger Leaf
Design Size - 9" x 24.25"

© Apricot Moon Designs

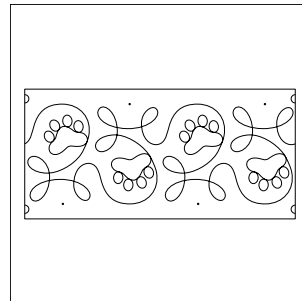

Ginger Paw
Design Size - 9" x 24.5"

© Melonie J. Caldwell & Apricot Moon Designs

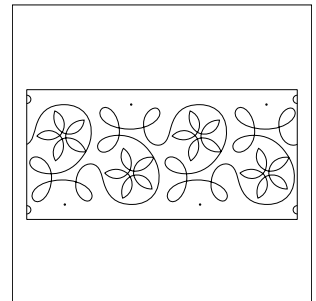

Ginger Spring
Design Size - 9" x 24.5"

© Apricot Moon Designs

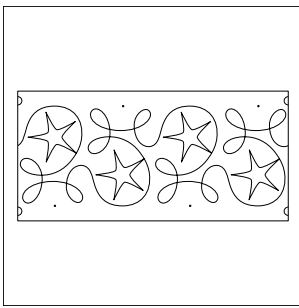

Ginger Star
Design Size - 9" x 24.5"
© Apricot Moon Designs

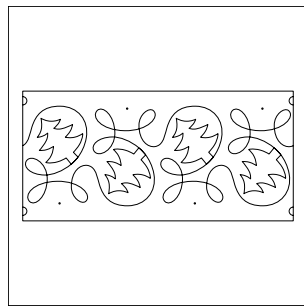

Ginger Tree
Design Size - 9" x 24.5"
© Melonie J. Caldwell & Apricot Moon Designs

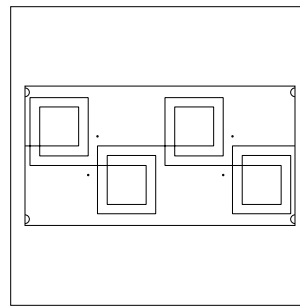

Gingham Plaid
Design Size - 10" x 23.25"
© Patricia E. Ritter

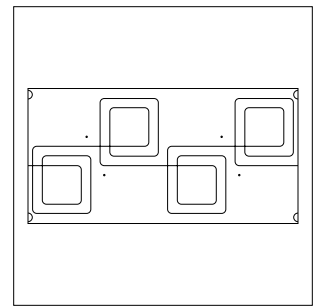

Gingham Plaid - Bias Cut
Design Size - 10" x 23.5"
© Patricia E. Ritter

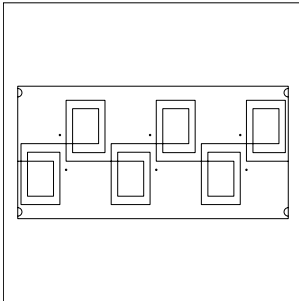

Gingham Plaid - Elongated
Design Size - 9.25" x 24"
© Patricia E. Ritter

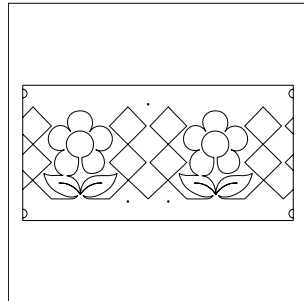

Gingham Posies - Border
Design Size - 8" x 23.5"
© Maureen Foster / Humble Bee Quilting

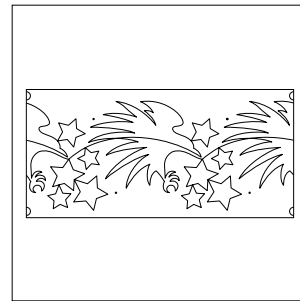

Glory
Design Size - 10" x 24.5"
© Sarah Ann Myers

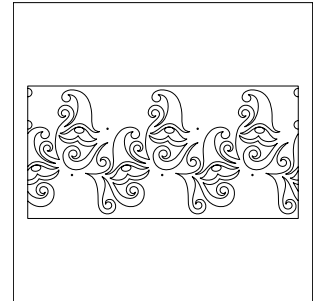

Gnomes Party
Design Size - 11" x 24"
© Lakeridge Designs / Kimberly Dewling

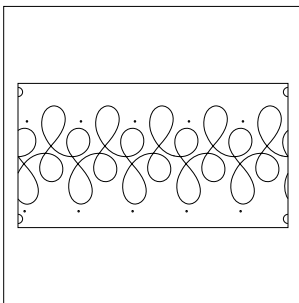

Going loopy
Design Size - 8" x 22"
© Naomi Hynes

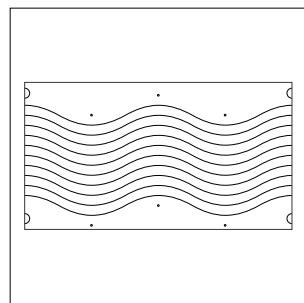

Good Vibrations #1
Single Row Size - 1.5" x 20"
© Patricia E. Ritter

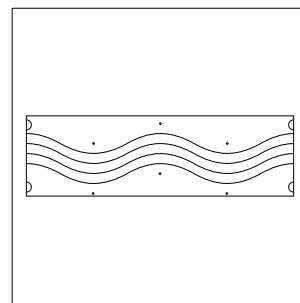

Good Vibrations #1 - Petite
Single Row Size - 1.5" x 20"
© Patricia E. Ritter

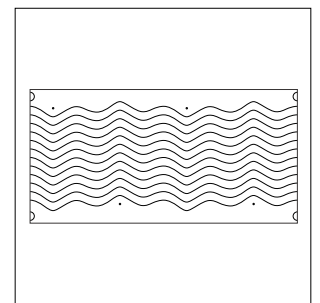

Good Vibrations #2
Single Row Size - 1.25" x 23.5"
© Patricia E. Ritter

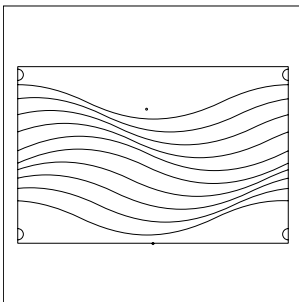

Good Vibrations - Offset
Design Size - 10" x 18"
© Patricia E. Ritter

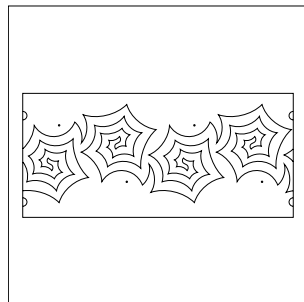

Gossamer
Design Size - 8.75" x 24"
© Hermione Agee

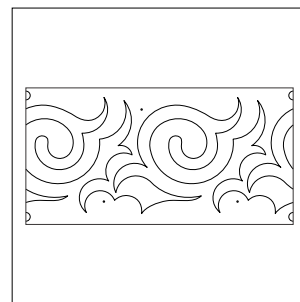

Gothic
Design Size - 10" x 23"
© Keryn Emmerson

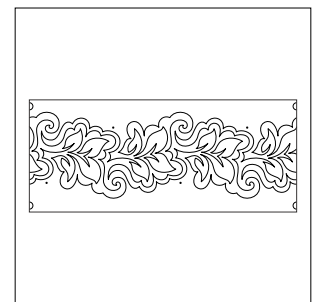

Grandio
Design Size - 9" x 28"
© Hermione Agee

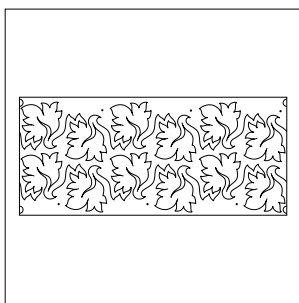

Grape Leaves
Single Row Size - 6.25" x 27.75"
© Patricia E. Ritter

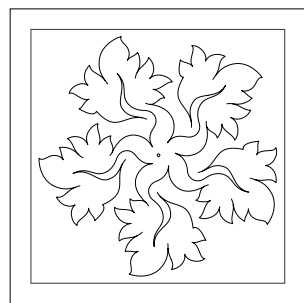

Grape Leaves - Block
Design Size - 11" x 11"
© Patricia E. Ritter

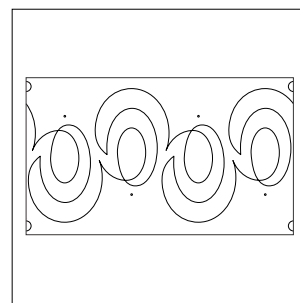

Gravity
Design Size - 10" x 20"
© Melonie J. Caldwell

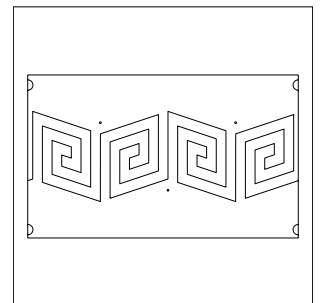

Greek Key Book
Design Size - 6.5" x 19.5"
© Kalynda Grant

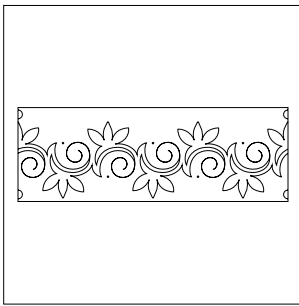

Green Tea
Design Size - 6.5" x 23"

© Patricia E. Ritter & Jeffery Schillinger

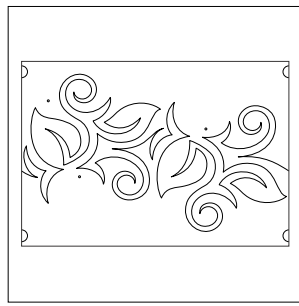

Greenhouse - Set
Set Size - 10" x 34"

© Patricia E. Ritter & Tracey Russell

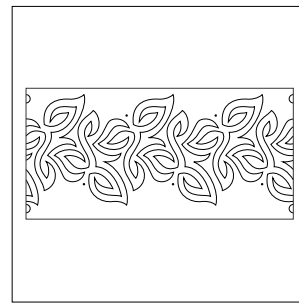

Ground Cover
Design Size - 10" x 24"

© Barbara Becker

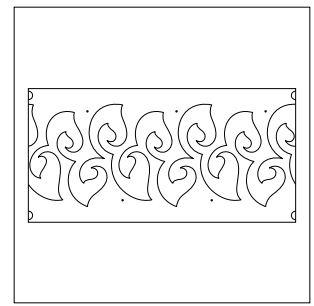

Gryphon
Design Size - 9" x 23.5"

© Hermione Agee

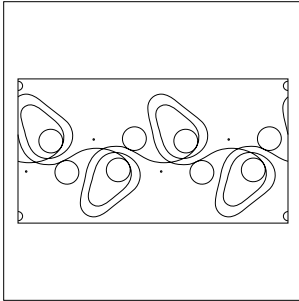

Guacamole
Design Size - 10" x 22"

© Melonie J. Caldwell

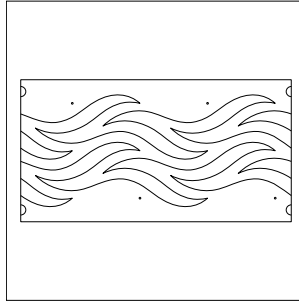

Gulf Stream
Single Row Size - 4.75" x 20"

© Patricia E. Ritter, Marc & Lynne Cohen

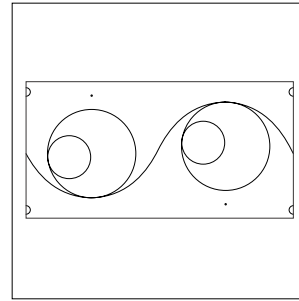

Gumball
Design Size - 8.5" x 23.5"

© Patricia E. Ritter & Tracey Russell

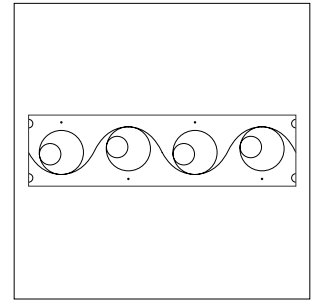

Gumball - Petite - 1 Row
Design Size - 4.25" x 23.5"

© Patricia E. Ritter & Tracey Russell

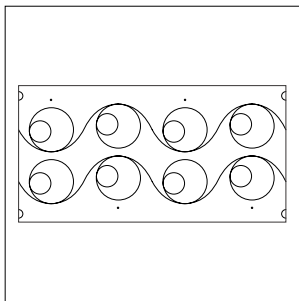

Gumball - Petite - 2 Row
Single Row Size - 4.25" x 23.5"

© Patricia E. Ritter & Tracey Russell

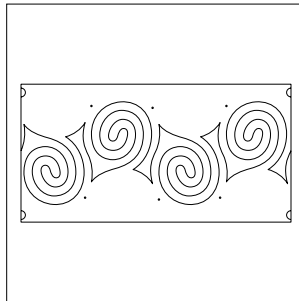

Gyre
Design Size - 8.75" x 23"

© Naomi Hynes

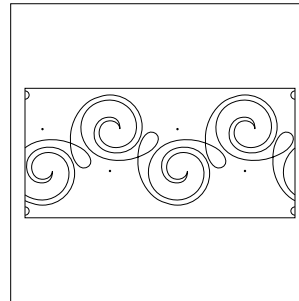

Happy
Design Size - 10" x 24.5"

© Patricia E. Ritter & Denise Schillinger

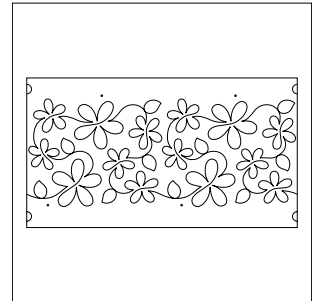

Happy Flowers
Design Size - 8.5" x 21.25"

© It's A Quilt Thing

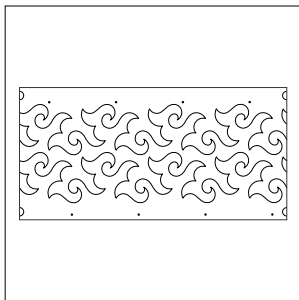

Happy Times
Single Row Size - 4.5" x 23.75"

© Hermione Agee

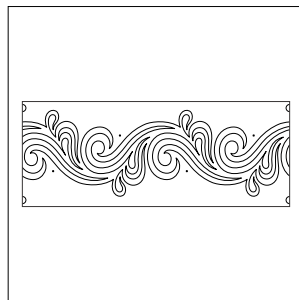

Harbour Wave
Design Size - 9" x 28"

© Patricia E. Ritter & Marybeth O'Halloran

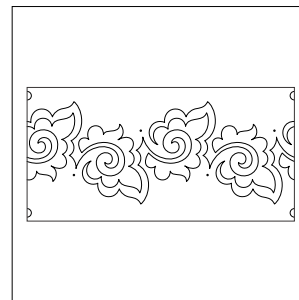

Harmony
Design Size - 9" x 23.5"

© Patricia E. Ritter & Valerie Smith

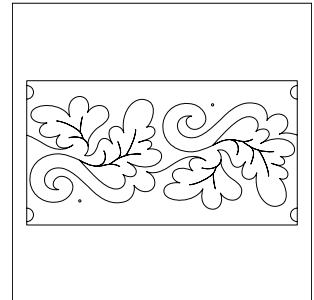

Harvest Winds - Petite - Set
Set Size - 6.25" x 30"

© Patricia E. Ritter

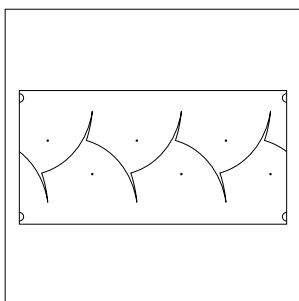

Hashi
Design Size - 8" x 23.5"

© Keryn Emmerson

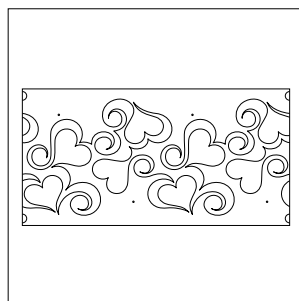

Heart Fancy
Design Size - 10" x 23"

© Apricot Moon Designs

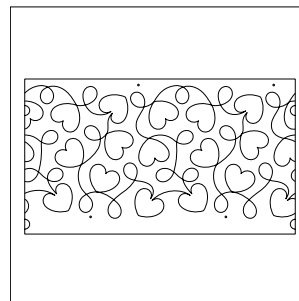

Heart Meander
Design Size - 10" x 20.5"

© It's A Quilt Thing

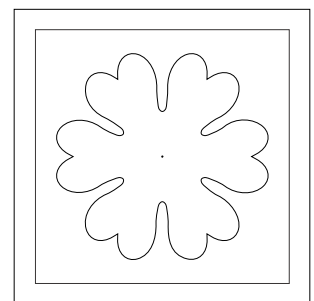

Heart Ring - Block
Design Size - 5" x 5"

© R&S Designs

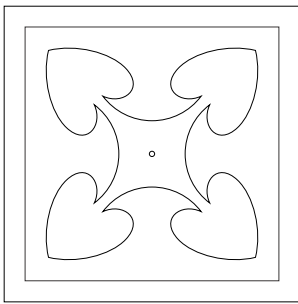

Heart Square - Block
Design Size - 5" x 5"

© R&S Designs

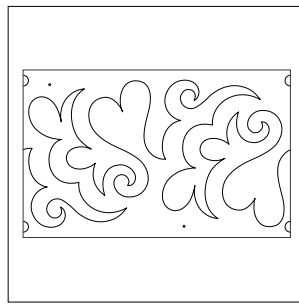

Hearts A Flutter - Set
Set Size - 10.25" x 37.5"

© Lisa H. Calle

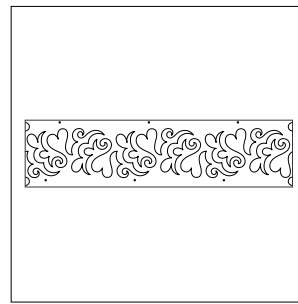

Hearts A Flutter - Petite
Design Size - 4.5" x 24"

© Lisa H. Calle

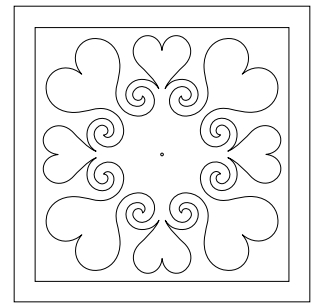

Hearts Abound - Block
Design Size - 11" x 11"

© Lisa H. Calle

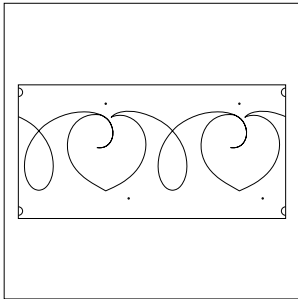

Hearts and Loops
Design Size - 7" x 23.5"

© Darlene Epp

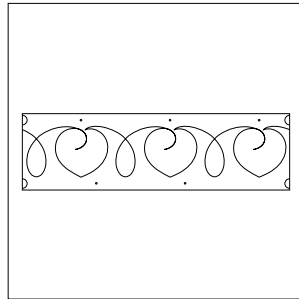

Hearts and Loops - Petite
Design Size - 4" x 21"

© Darlene Epp

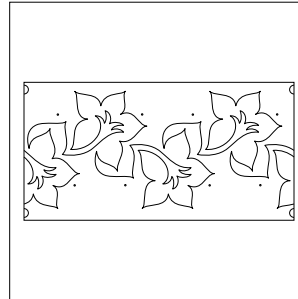

Heidi
Design Size - 10" x 23"

© Hermione Agee

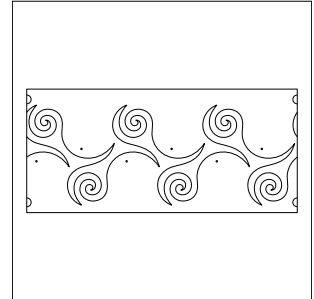

Helico
Design Size - 8.5" x 23"

© Sarah Ann Myers

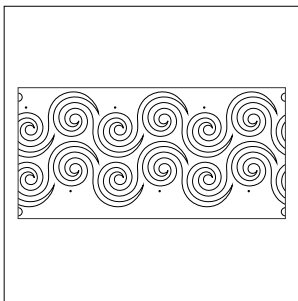

Helix
Single Row Size - 6" x 24.5"

© Patricia E. Ritter

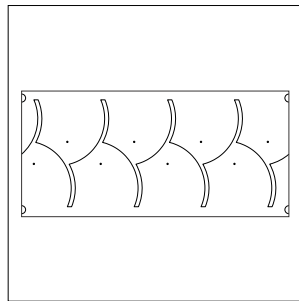

Helm
Design Size - 10" x 25"

© Keryn Emmerson

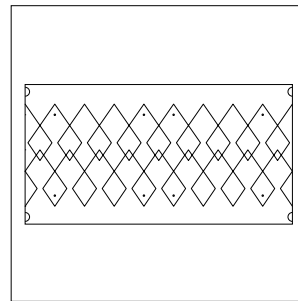

Herringbone #1
Single Row Size - 4.75" x 22.5"

© Patricia E. Ritter & Leisha Farnsworth

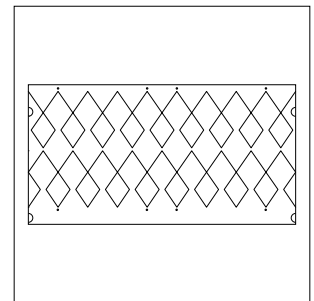

Herringbone #2
Single Row Size - 4.75" x 22.5"

© Patricia E. Ritter & Leisha Farnsworth

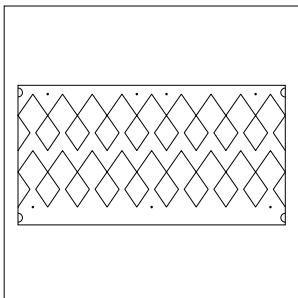

Herringbone #3
Single Row Size - 4.75" x 22.5"

© Patricia E. Ritter & Leisha Farnsworth

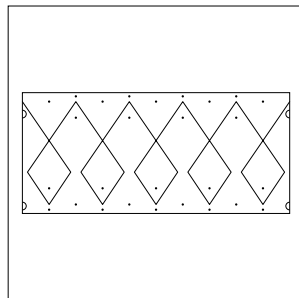

Herringbone - Grande
Design Size - 10" x 26"

© Patricia E. Ritter & Leisha Farnsworth

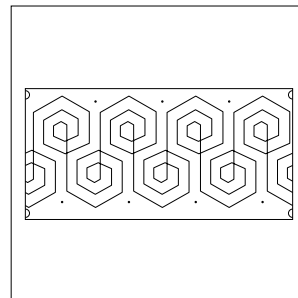

Hex Marks the Spot
Design Size - 10" x 24"

© Patricia E. Ritter

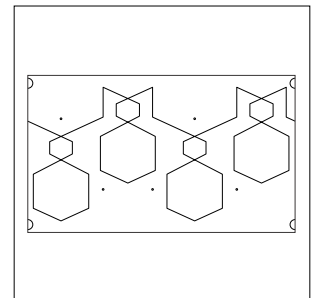

Hexcellent
Design Size - 10" x 20"

© Apricot Moon Designs

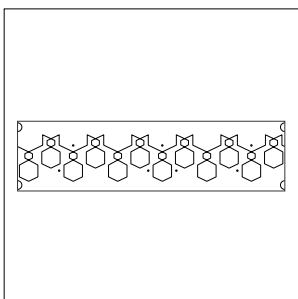

Hexcellent - Petite
Design Size - 4" x 23"

© Apricot Moon Designs

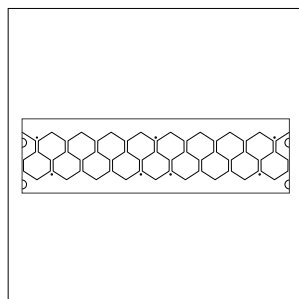

Hexies - Petite - 1 Row
Design Size - 4" x 22.5"

© Patricia E. Ritter

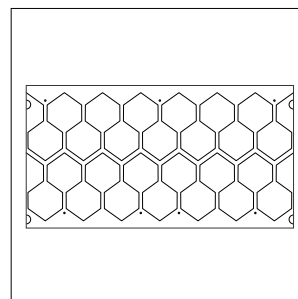

Hexies - Petite - 2 Row
Single Row Size - 5.75" x 22.5"

© Patricia E. Ritter

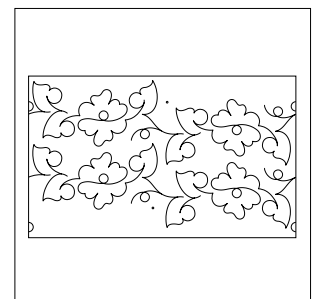

Hibiscus
Single Row Size - 6.75" x 21.5"

© Patricia E. Ritter

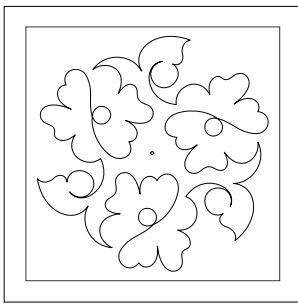

Hibiscus - Block #1
Design Size - 10" x 10"
© Patricia E. Ritter

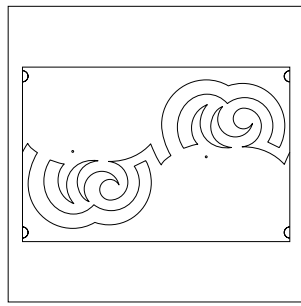

Hieroglyphs - Set
Set Size - 10" x 36"
© Sarah Ann Myers

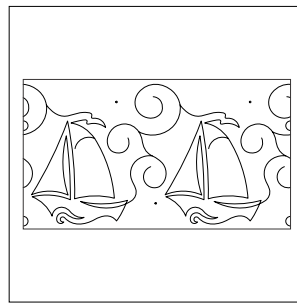

High Seas
Design Size - 11" x 21"
© Hermione Agee

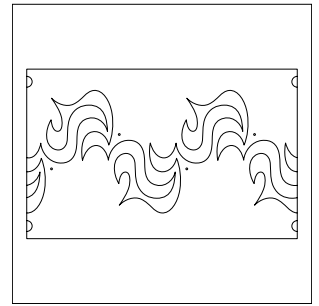

High Tide
Design Size - 8.5" x 18.75"
© Melonie J. Caldwell

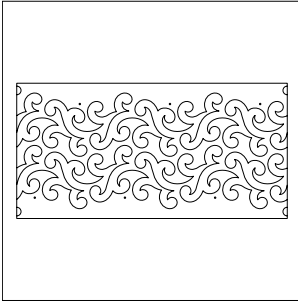

Highland - Petite
Single Row Size - 5.5" x 23.5"
© Patricia E. Ritter

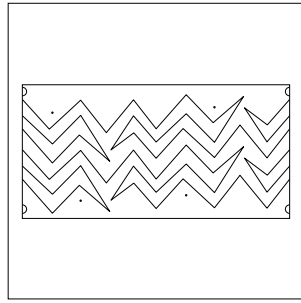

Himalayas
Single Row Size - 6" x 23.5"
© Sarah Ann Myers

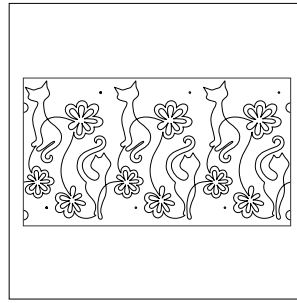

Hip Kitties
Design Size - 11" x 21.25"
© Denise Schilling

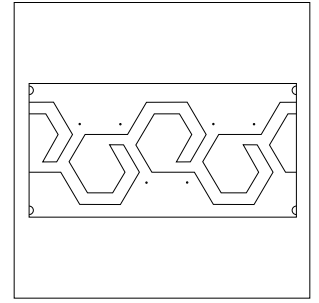

Hive
Design Size - 9" x 23.5"
© Sarah Ann Myers

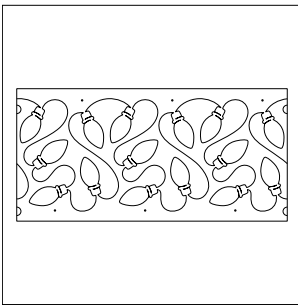

Holiday Lights
Design Size - 10" x 24"
© Jessica Schick

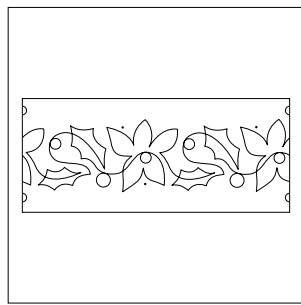

Holly and Poinsettia #1
Design Size - 6.5" x 23.5"
© Dave Hudson

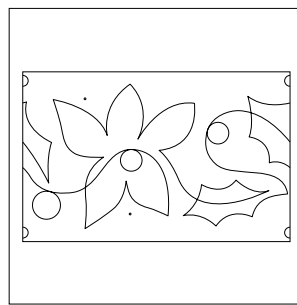

Holly and Poinsettia #2 - Set
Set Size - 10" x 37"
© Dave Hudson

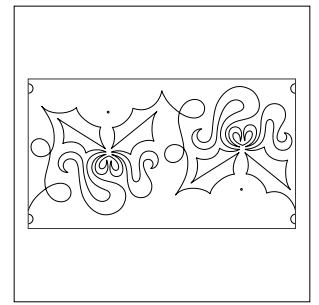

Holly Bows
Design Size - 10" x 21"
© Lisa H. Calle

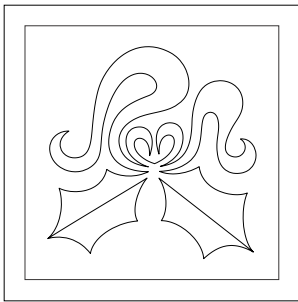

Holly Bows - Block
Design Size - 8.25" x 8.25"
© Lisa H. Calle

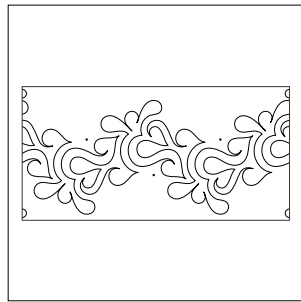

Holly's Hearts
Design Size - 10" x 23.5"
© Patricia E. Ritter

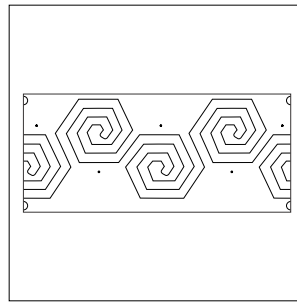

Honeycomb
Design Size - 8.75" x 23.75"
© Patricia E. Ritter

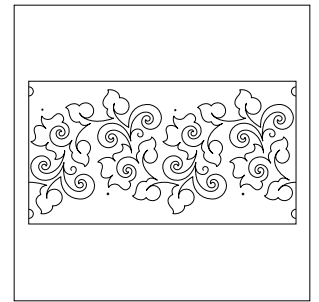

Honeysuckle
Design Size - 10.25" x 22"
© Patricia E. Ritter

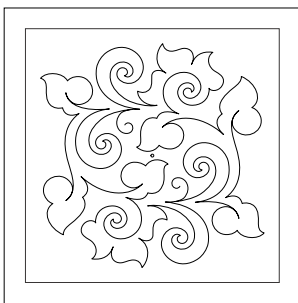

Honeysuckle - Block
Design Size - 9.75" x 9.75"
© Patricia E. Ritter

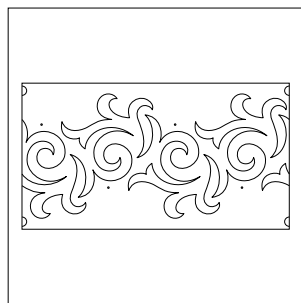

Hook, Line and Sinker
Design Size - 10" x 21.5"
© Sarah Ann Myers

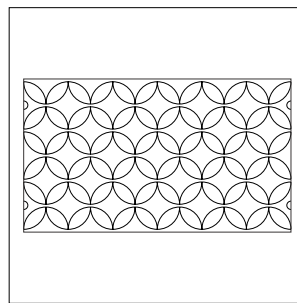

Hoops
Single Row Size - 2" x 24"
© R&S Designs

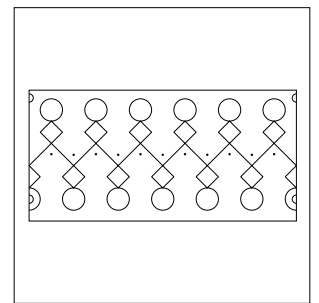

Hopscotch
Design Size - 10" x 24"
© Leisha Farnsworth

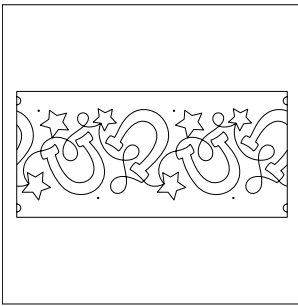

Horseshoes
Design Size - 8.5" x 25.25"
© Jessica Schick

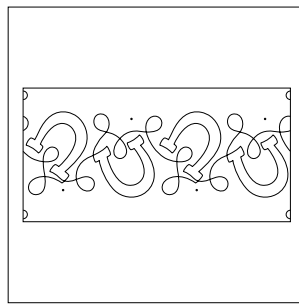

Horseshoes and Loops
Design Size - 7.5" x 23.5"
© Jessica Schick

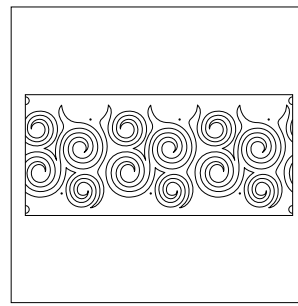

Hot Coffee
Design Size - 10" x 26"
© Apricot Moon Designs

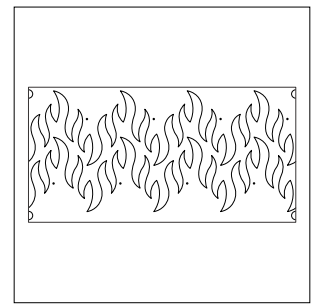

Hot Rod
Single Row Size - 6.75" x 23.75"
© Hermione Agee

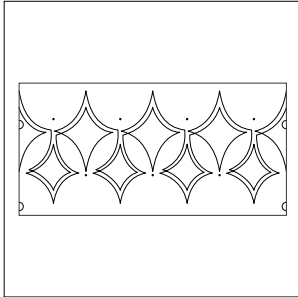

Houndstooth
Design Size - 10" x 23.75"
© Melonie J. Caldwell

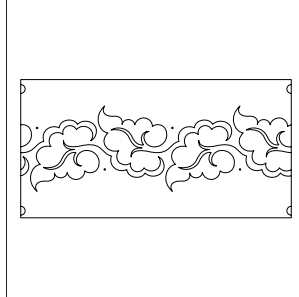

Hoya Leaves
Design Size - 7.25" x 23"
© Jessica Schick

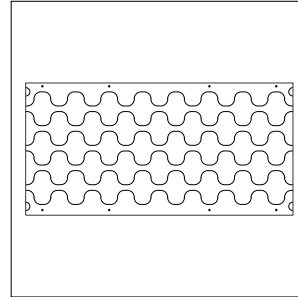

Humps
Double Row Size - 3" x 23.75"
© R&S Designs

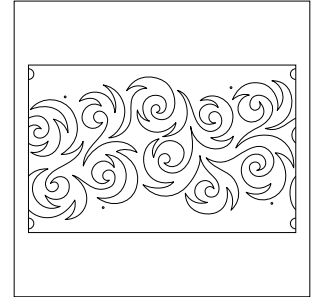

Hurricane - Set
Set Size - 10" x 37.5"
© Kristin Hoftzyer

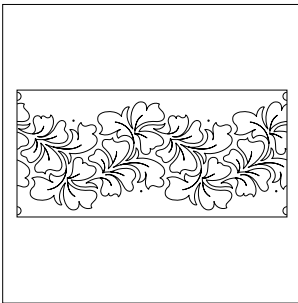

Hyacinth - Grande
Design Size - 10" x 25"
© Patricia E. Ritter

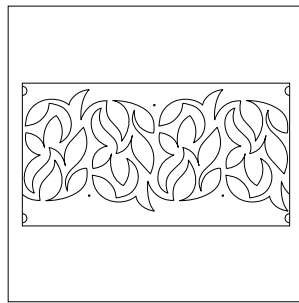

Hyde Park
Design Size - 10" x 22"
© Sarah Ann Myers

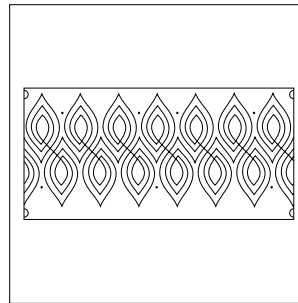

Ikat #1
Design Size - 10" x 24"
© Patricia E. Ritter

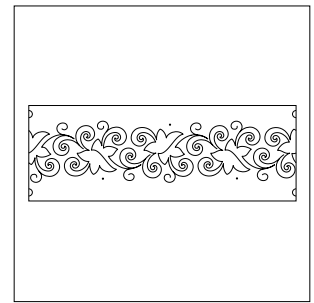

Independence Day
Design Size - 6.5" x 28"
© Patricia E. Ritter

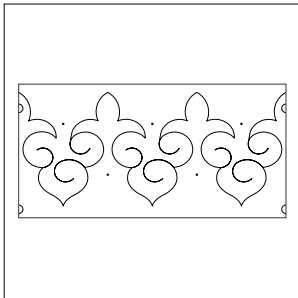

India
Design Size - 10" x 23.5"
© Keryn Emmerson

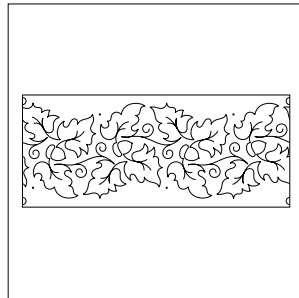

Indian Summer #1
Design Size - 10" x 28"
© Patricia E. Ritter

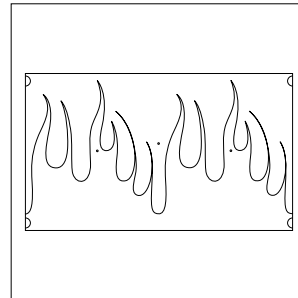

Inferno
Design Size - 10" x 20"
© Jessica Schick

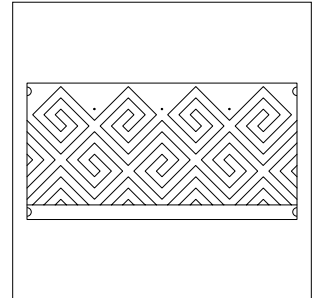

Interlocking Square
Single Row Size - 6" x 23.75"
© R&S Designs

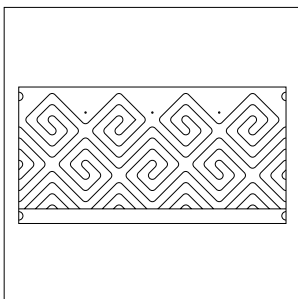

Interlocking Square - Rounded
Single Row Size - 5.75" x 23.75"
© R&S Designs

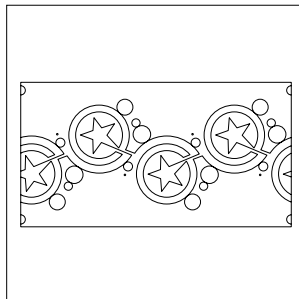

Iridescent
Design Size - 9" x 22"
© Patricia E. Ritter & Jeffery Schillinger

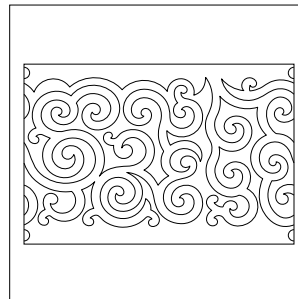

Irish Swirls - Set
Set Size - 10" x 36"
© Deb Geissler

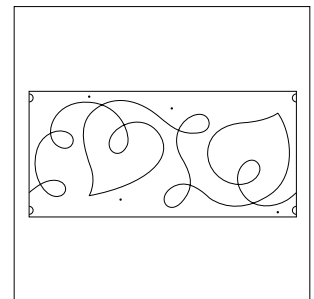

Ivy Vine #1
Design Size - 10" x 25"
© Dave Hudson

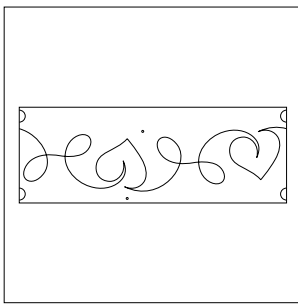

Ivy Vine - Border - Set
Set Size - 4" x 33.5"
© Dave Hudson

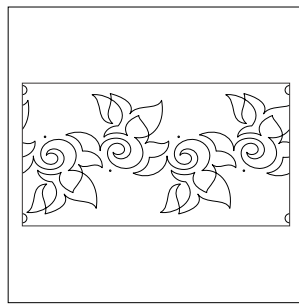

Jacob's Ladder
Design Size - 10" x 22"
© Patricia E. Ritter

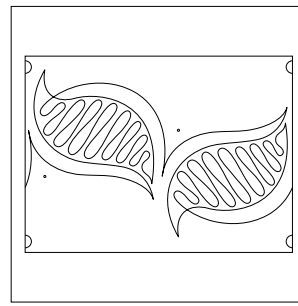

Jacquard - Set
Set Size - 10" x 32"
© Patricia E. Ritter & Tracey Russell

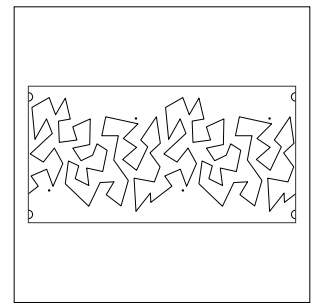

Jagged Stipple
Design Size - 10" x 23.5"
© Patricia E. Ritter & Tracey Russell

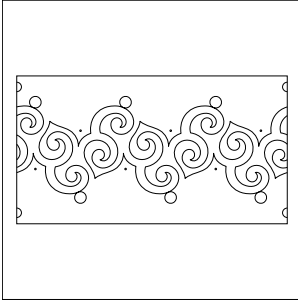

Jamboree
Design Size - 8.5" x 21.5"
© Patricia E. Ritter

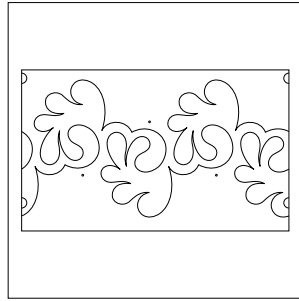

Japanese Waves
Design Size - 10" x 19.5"
© Hermione Agee

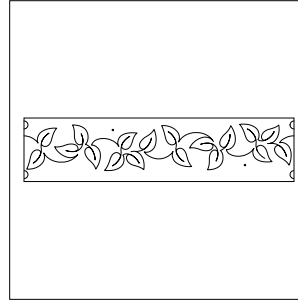

Jasmine - 1 Row
Design Size - 4.5" x 25.5"
© Patricia E. Ritter

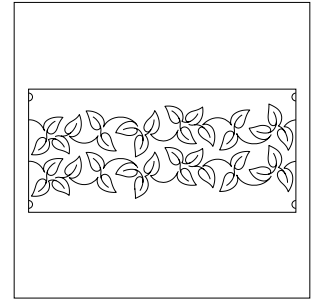

Jasmine - 2 Row
Single Row Size - 5" x 25.5"
© Patricia E. Ritter

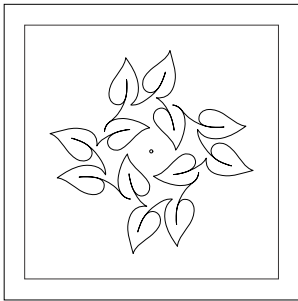

Jasmine - Block #3
Design Size - 8" x 8"
© Patricia E. Ritter

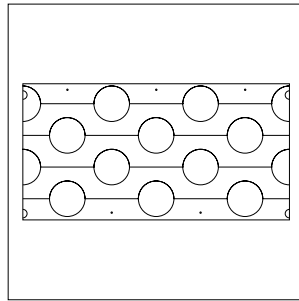

Jessica's Abacus #1
Single Row Size - 3.25" x 23.5"
© Jessica Schick

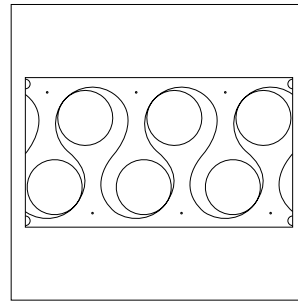

Jessica's Loop D Loop
Design Size - 10.25" x 21"
© Jessica Schick

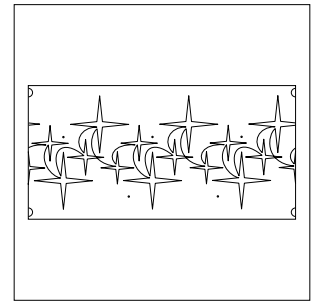

Jessica's Twinkle
Design Size - 10" x 23.5"
© Jessica Schick

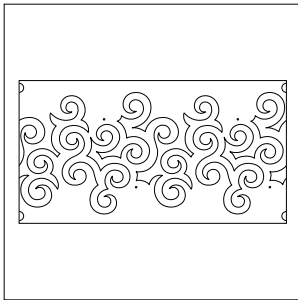

Jessie's Swirls
Design Size - 10" x 22"
© Jessica Schick

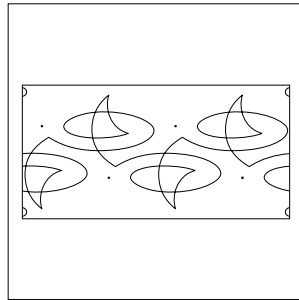

Jester
Design Size - 10" x 23.5"
© Melonie J. Caldwell

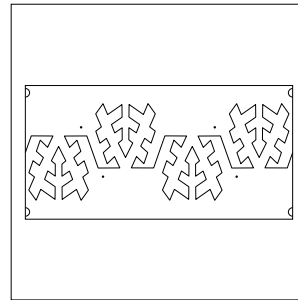

Jolt
Design Size - 8.5" x 23.5"
© Sarah Ann Myers

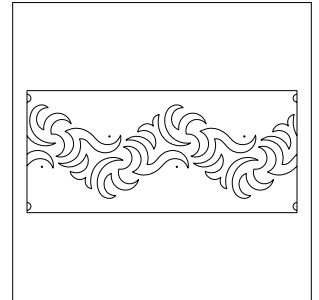

Junket
Design Size - 9" x 26"
© Melonie J. Caldwell

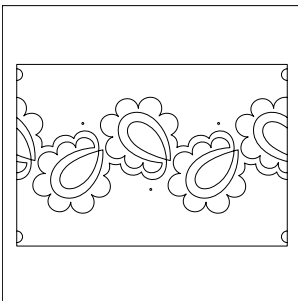

Kaffan
Design Size - 7.5" x 17.5"
© Patricia E. Ritter & Jeffery Schillinger

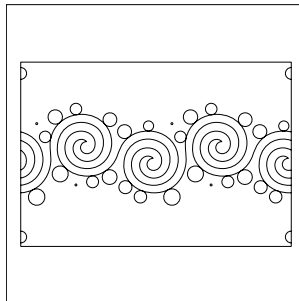

Kalynda's Pearls and Swirls
Design Size - 6.5" x 17.25"
© Kalynda Grant

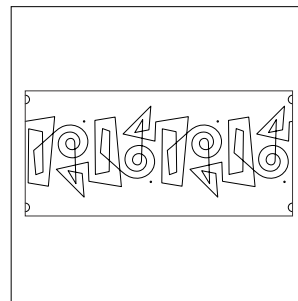

Kandinsky
Design Size - 8" x 23.5"
© Patricia E. Ritter

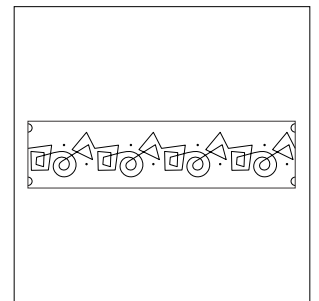

Kandinsky - Petite
Design Size - 4" x 24"
© Patricia E. Ritter

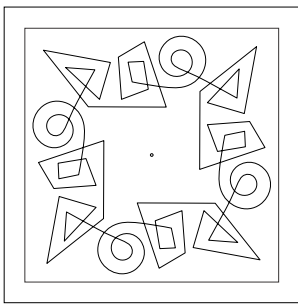

Kandinsky - Block #1
Design Size - 11" x 11"
© Patricia E. Ritter

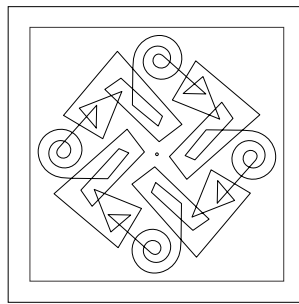

Kandinsky - Block #2
Design Size - 11" x 11"
© Patricia E. Ritter

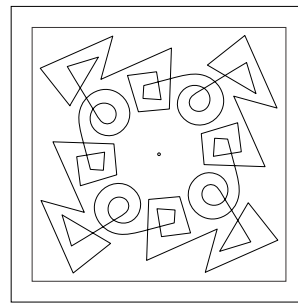

Kandinsky - Block #3
Design Size - 11" x 11"
© Patricia E. Ritter

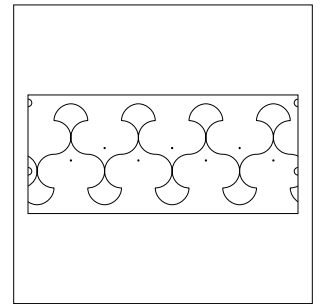

Kapari
Design Size - 10" x 26.75"
© Leisha Farnsworth

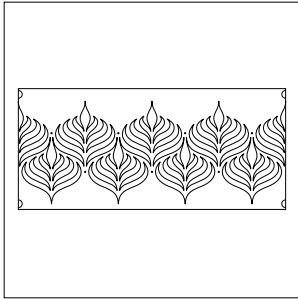

Karma
Design Size - 10" x 26"
© Patricia E. Ritter

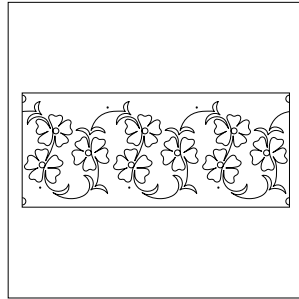

Kauai
Design Size - 10" x 27.5"
© Patricia E. Ritter

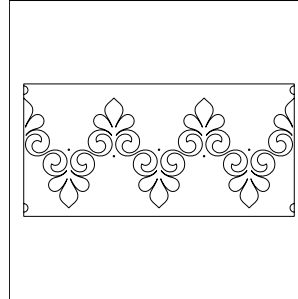

Kaylee's Fleur De Lys
Design Size - 9.75" x 24"
© Patricia E. Ritter & Helen Squire

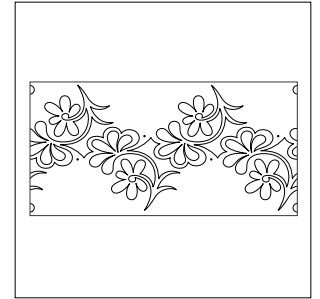

Keepsake
Design Size - 11" x 23.5"
© Patricia E. Ritter

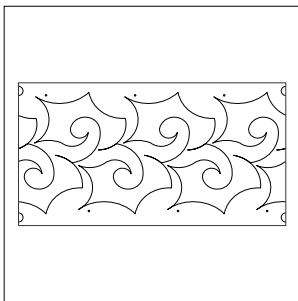

Kelpie
Design Size - 10" x 22"
© Keryn Emmerson

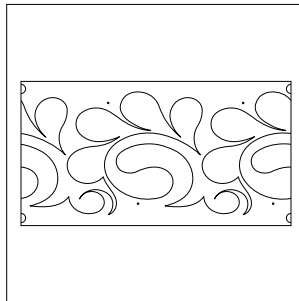

Keltin
Design Size - 10" x 22"
© Keryn Emmerson

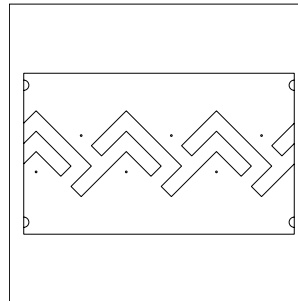

Keryn's Chevrons #1
Design Size - 6.25" x 19.75"
© Keryn Emmerson

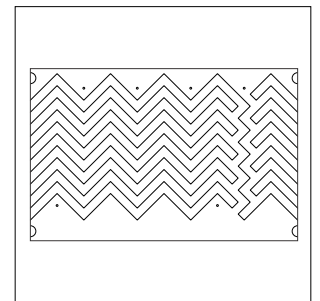

Keryn's Chevrons Multi - Set
Set Size - 10" x 36.5"
© Keryn Emmerson

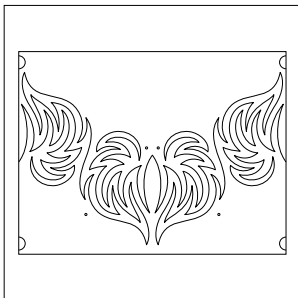

Kimchi - Set
Set Size - 10" x 31"
© Sarah Ann Myers

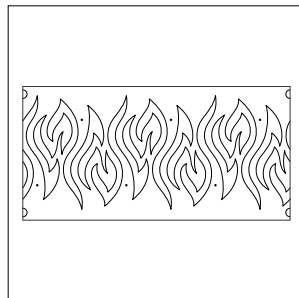

Kindling
Design Size - 10" x 23.5"
© Patricia E. Ritter & Leisha Farnsworth

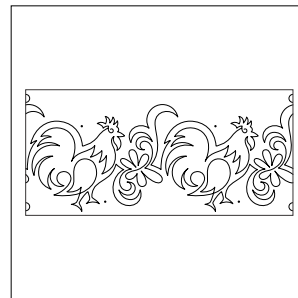

King of the Coop
Design Size - 10" x 25"
© Kyla Trammell

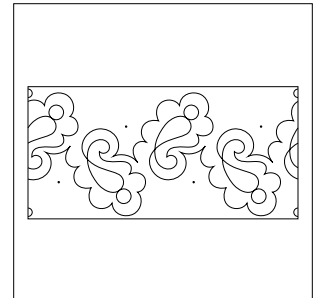

Kiss
Design Size - 11" x 24"
© Melonie J. Caldwell

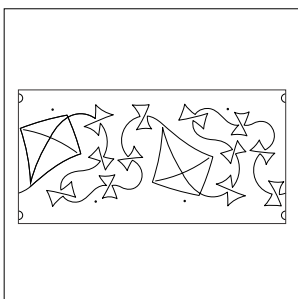

Kites
Design Size - 9" x 23.5"
© Hermione Agee

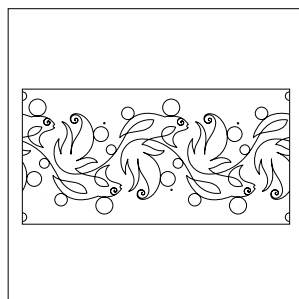

Koi
Design Size - 10" x 23.25"
© Melonie J. Caldwell

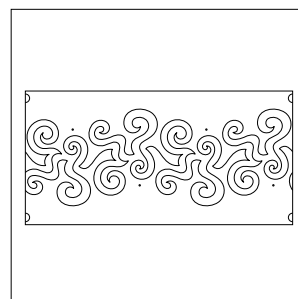

Kraken
Design Size - 8.5" x 23.5"
© Hermione Agee

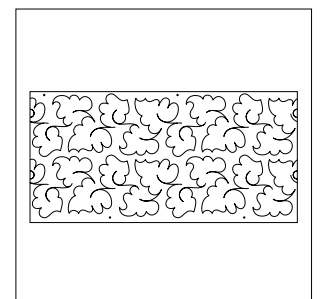

Kudzu
Single Row Size - 5.75" x 24.5"
© Patricia E. Ritter

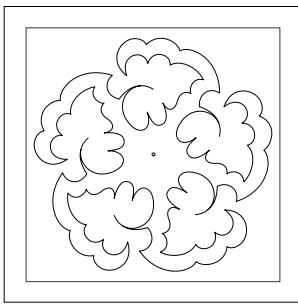

Kudzu - Block
Design Size - 11" x 10.75"
© Patricia E. Ritter

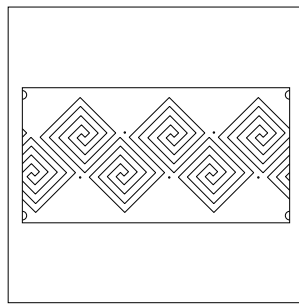

Labyrinth
Design Size - 10" x 23.25"
© Patricia E. Ritter

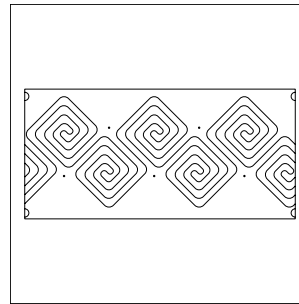

Labyrinth - Bias Cut
Design Size - 10" x 24.5"
© Patricia E. Ritter

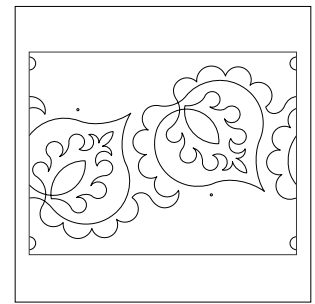

Lace - Set
Set Size - 10" x 31"
© Hermione Agee

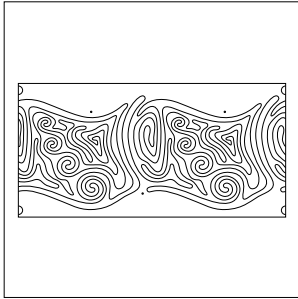

Lace Agate Meander
Design Size - 10" x 23.5"
© Bethanne Nemes

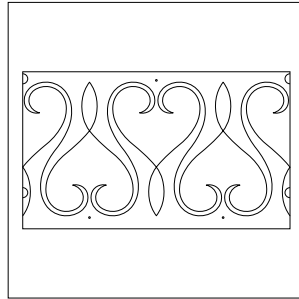

Lace Heart - Border
Design Size - 10" x 20"
© Laura Estes

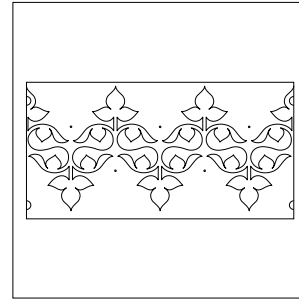

Lacy Leaves
Design Size - 10.75" x 23"
© Jessica Schick

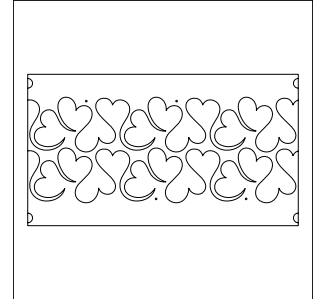

Lakeridge's Love Is
Single Row Size - 4.25" x 21"
© Lakeridge Designs / Kimberly Dewling

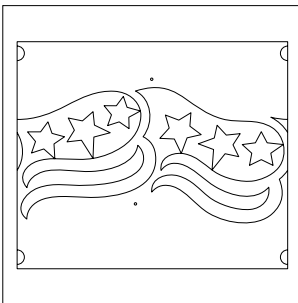

Lakeridge's Patriotic - Set
Set Size - 7" x 28"
© Lakeridge Designs / Kimberly Dewling

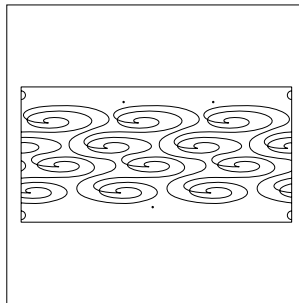

Lakeridge's Puddles
Design Size - 8.5" x 23.5"
© Lakeridge Designs / Kimberly Dewling

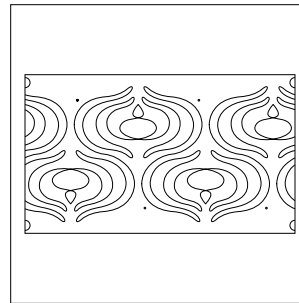

Lantern
Design Size - 10" x 20"
© Naomi Hynes

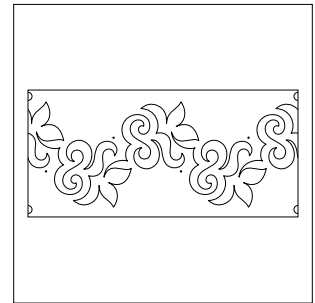

Lapis
Design Size - 9.75" x 25"
© Sarah Ann Myers

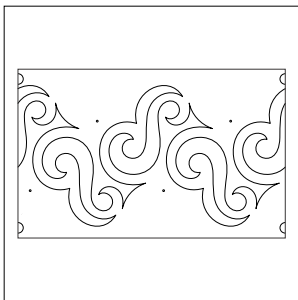

Latte
Design Size - 10" x 19"
© Sarah Ann Myers

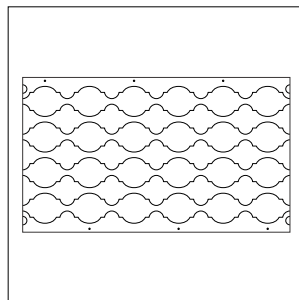

Lattice Keyhole
Double Row Size - 2.75" x 23.75"
© R&S Designs

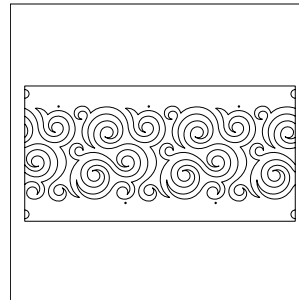

Laurie's Whirlpools
Design Size - 8.25" x 23.5"
© It's A Quilt Thing

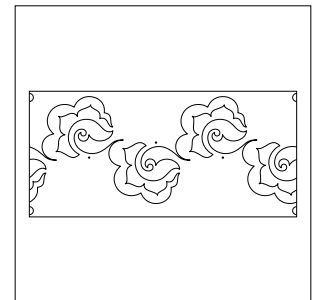

Leaf Bloom
Design Size - 10" x 25"
© Hermione Agee

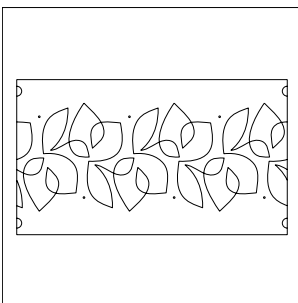

Leaf Out
Design Size - 8.25" x 20.5"
© Mel St. Clair

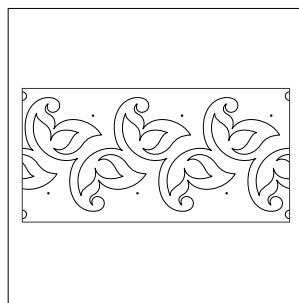

Leaflet
Design Size - 10" x 23.5"
© Hermione Agee

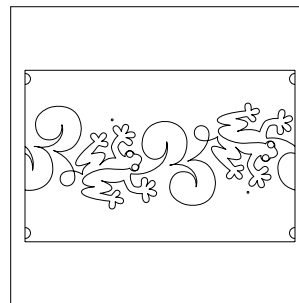

Leap Frog - Set
Set Size - 7.25" x 37"
© Patricia E. Ritter

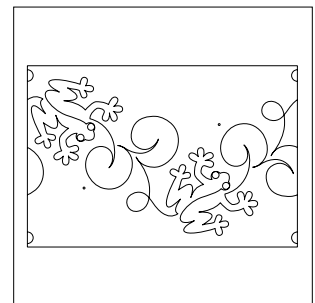

Leap Frog - Grande - Set
Set Size - 10.25" x 35"
© Patricia E. Ritter

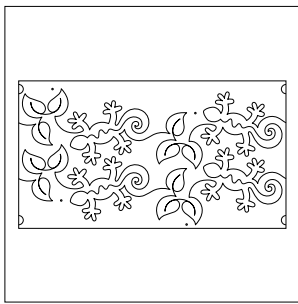

Leapin' Lizardz
Single Row Size - 6.5" x 21.75"
© Patricia E. Ritter

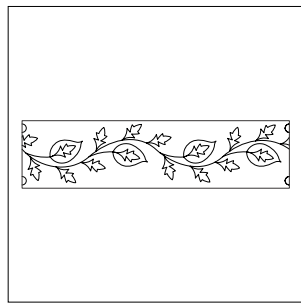

Leaves
Design Size - 5.25" x 23.75"
© R&S Designs

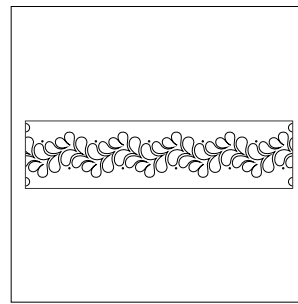

Lei - Petite
Design Size - 4" x 23.75"
© Patricia E. Ritter & Nancy Read

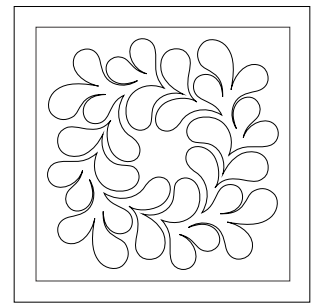

Lei - Block
Design Size - 10" x 10"
© Patricia E. Ritter & Nancy Read

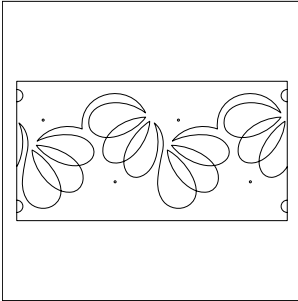

Lemon Peel - Set
Set Size - 7" x 33"
© Lakeidge Designs / Kimberly Dewling

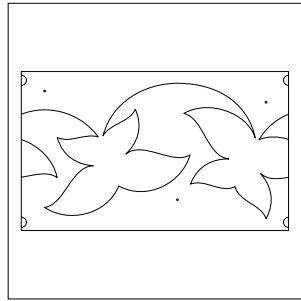

Lepidoptera
Design Size - 10" x 19.75"
© Hermione Agee

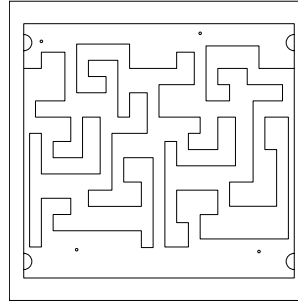

Level #2 Maze - Set
Set Size - 9.5" x 25"
© Tia L. Kennard

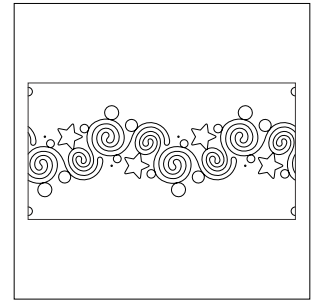

Liberty
Design Size - 8" x 23.5"
© Patricia E. Ritter & Leisha Farnsworth

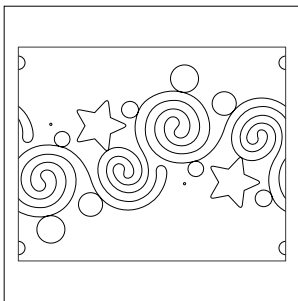

Liberty - Grande - Set
Set Size - 10" x 30"
© Patricia E. Ritter & Leisha Farnsworth

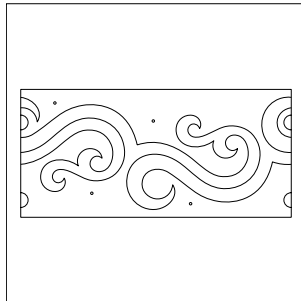

Licorice - Set
Set Size - 5.75" x 27.5"
© Patricia E. Ritter & Tracey Russell

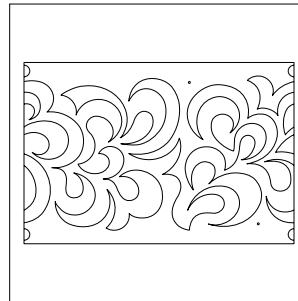

Lida - Set
Set Size - 10" x 35"
© Keryn Emmerson

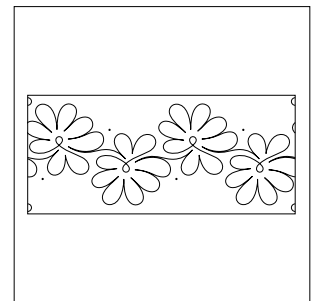

Lilac
Design Size - 10" x 26.75"
© Sarah Ann Myers

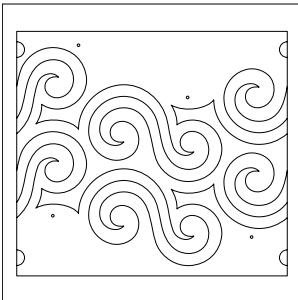

Lindy Hop - Set
Set Size - 6.5" x 26"
© Melonie J. Caldwell & Jeffery Schillinger

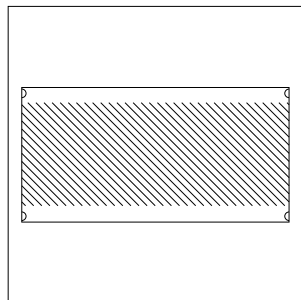

Lines - 45 Degrees - Left
Line Spacing - 1/2"
© R&S Designs

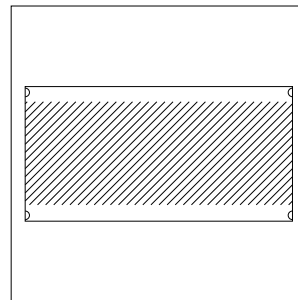

Lines - 45 Degrees - Right
Line Spacing - 1/2"
© R&S Designs

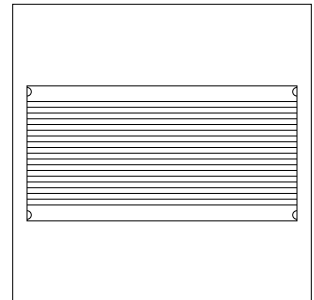

Lines - Horizontal
Line Spacing - 1/2"
© R&S Designs

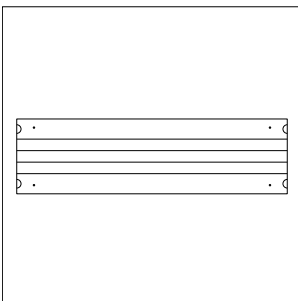

Lines - Horizontal - Petite
Line Spacing - 1"
© R&S Designs

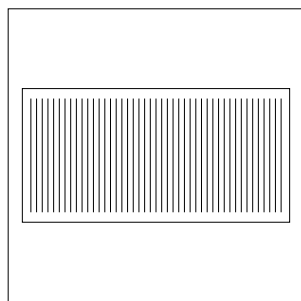

Lines - Vertical
Line Spacing - 1/2"
© R&S Designs

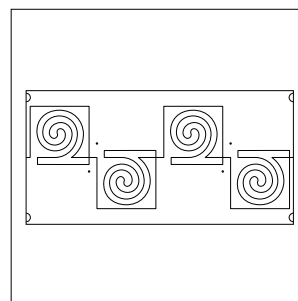

Linked in Four
Design Size - 9" x 23.5"
© Darlene Epp

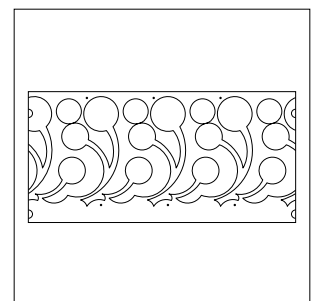

Lollipop Forest
Design Size - 10" x 24"
© Keryn Emmerson

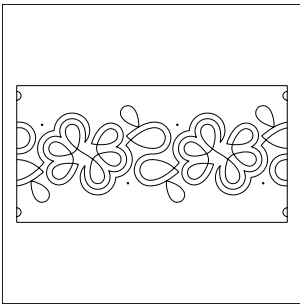

Loop Swoop
Design Size - 8.25" x 23.25"
© Mel St. Clair

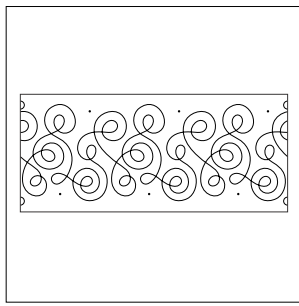

Loop the Loop
Design Size - 9" x 25"
© Barbara Becker

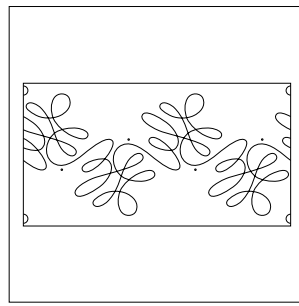

Loophole
Design Size - 10" x 22"
© Sarah Ann Myers

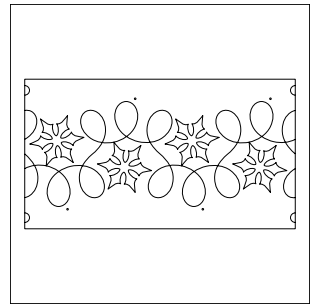

Loopy Snowflakes
Design Size - 8.25" x 21.25"
© Melissa Kelley

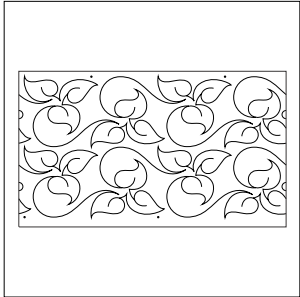

Loose Leaf
Single Row Size - 6.5" x 24.5"
© Patricia E. Ritter

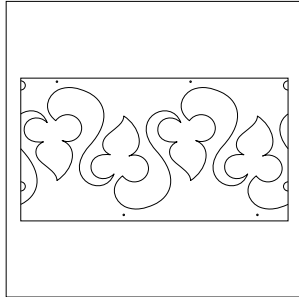

Lorien's Ace
Design Size - 10" x 22"
© Hermione Agee

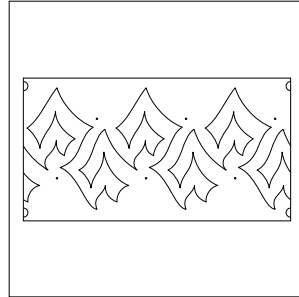

Lorien's Apex
Design Size - 10" x 22"
© Hermione Agee

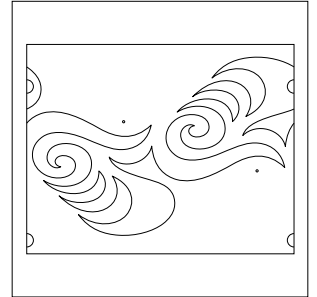

Lorien's Aqueous - Set
Set Size - 10" x 30"
© Hermione Agee

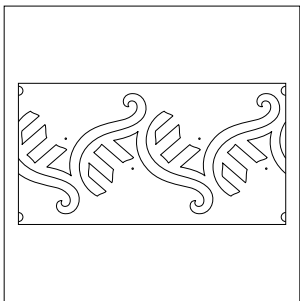

Lorien's Arcadia
Design Size - 10" x 22.25"
© Hermione Agee

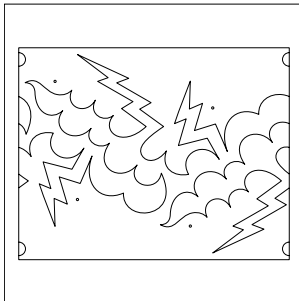

Lorien's Bolt - Set
Set Size - 11" x 30"
© Hermione Agee

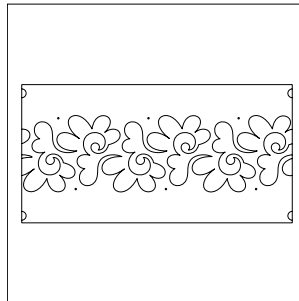

Lorien's Festival
Design Size - 6.5" x 23"
© Hermione Agee

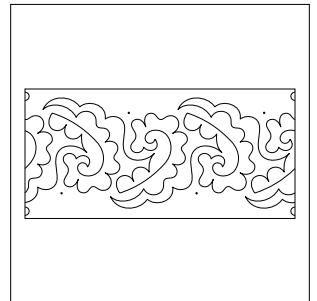

Lorien's Flamenco
Design Size - 10" x 24.5"
© Hermione Agee

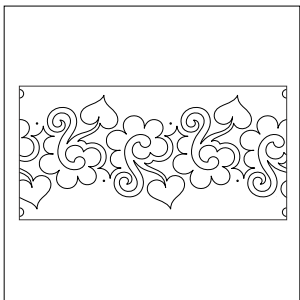

Lorien's Frolic
Design Size - 10" x 23.5"
© Hermione Agee

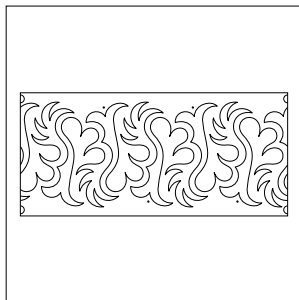

Lorien's Hawthorne
Design Size - 10" x 25.5"
© Hermione Agee

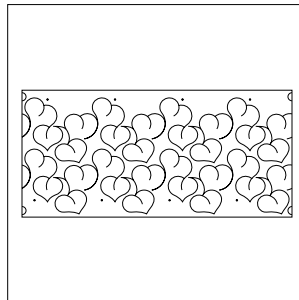

Lorien's Hearts Around
Single Row Size - 6" x 25"
© Hermione Agee

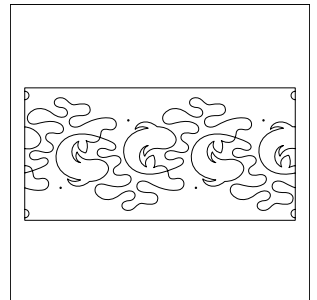

Lorien's Koi
Design Size - 10" x 24"
© Hermione Agee

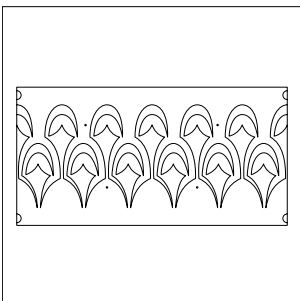

Lorien's Lantern
Design Size - 8.75" x 23"
© Hermione Agee

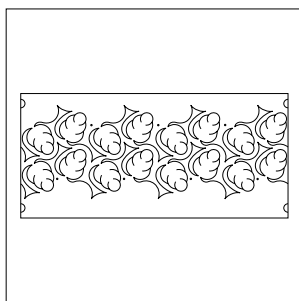

Lorien's Pinecone
Single Row Size - 5" x 23.75"
© Hermione Agee

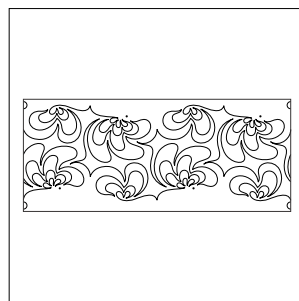

Lorien's Splat
Design Size - 10" x 28"
© Hermione Agee

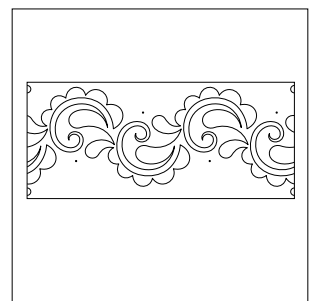

Lorien's Tapestry
Design Size - 10" x 27"
© Hermione Agee

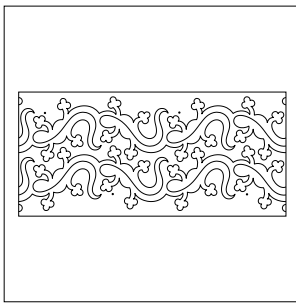

Lounge Lizards
Single Row Size - 6.75" x 28"
© Patricia E. Ritter

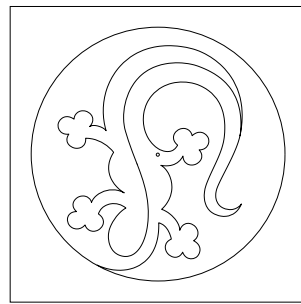

Lounge Lizard - Block
Design Size - 10.5" x 10.5"
© Patricia E. Ritter

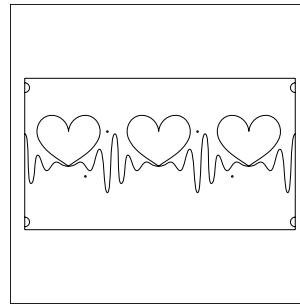

Love Line
Design Size - 6" x 21"
© Melonie J. Caldwell

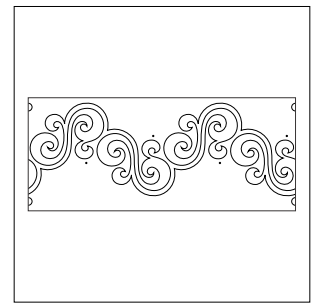

Lovely
Design Size - 9" x 26"
© Denise Schillinger

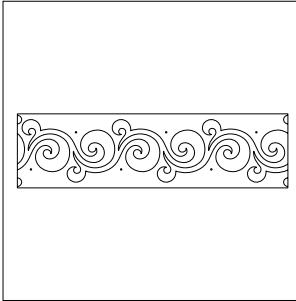

Lovely - Petite
Design Size - 5.5" x 23.75"
© Patricia E. Ritter & Denise Schillinger

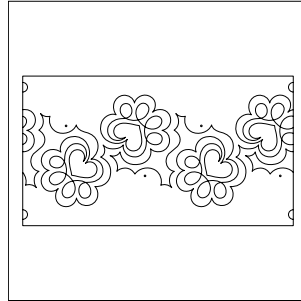

Loving Paws
Design Size - 8.75" x 21.25"
© Beany Girl Quilts

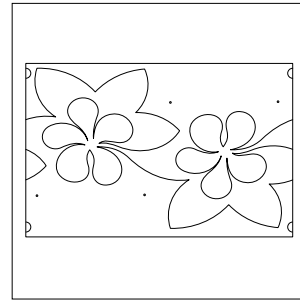

Luau
Design Size - 12" x 20"
© Hermione Agee

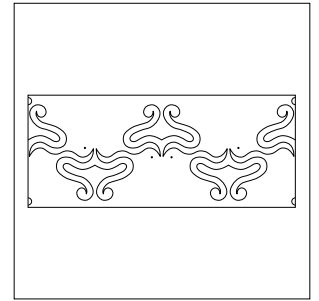

Lyn Frond
Design Size - 10" x 28"
© Naomi Hynes

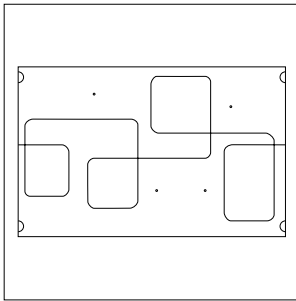

Mach 1 - Set
Set Size - 10" x 37"
© Apricot Moon Designs

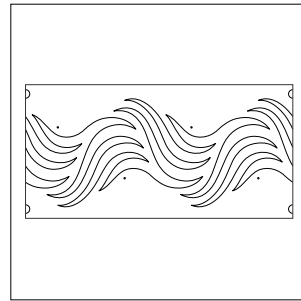

Macrame
Design Size - 9.5" x 23.5"
© Patricia E. Ritter

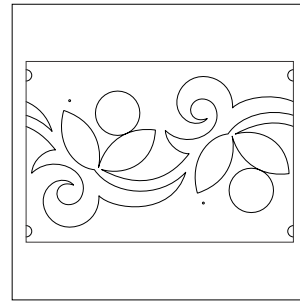

Mai Tai - Set
Set Size - 10" x 35.5"
© Sarah Ann Myers

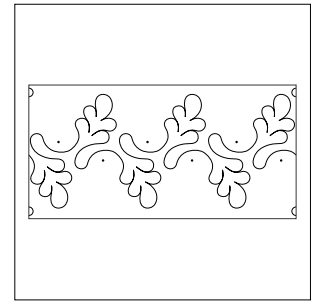

Maidenhair Fern
Design Size - 10" x 23.5"
© Patricia E. Ritter

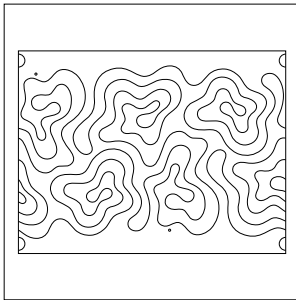

Malachite - Set
Set Size - 10" x 31"
© Patricia E. Ritter

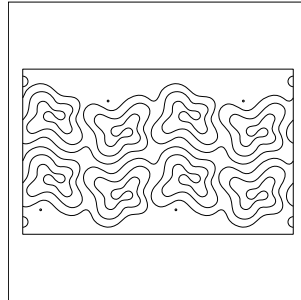

Malachite - Petite
Design Size - 5.75" x 19.25"
© Patricia E. Ritter

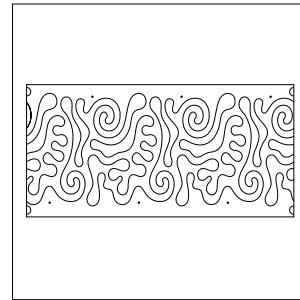

Mambo
Design Size - 10" x 23.75"
© Patricia E. Ritter & Marybeth O'Halloran

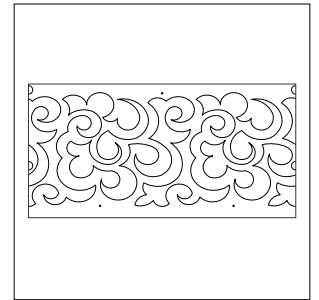

Mandarin Lace
Design Size - 10" x 23.5"
© Keryn Emmerson

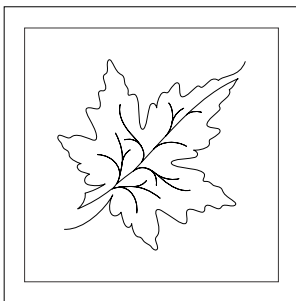

Maple Leaf - Block
Design Size - 6" x 6"
© R&S Designs

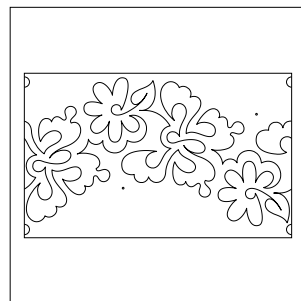

Mariposa
Design Size - 10.75" x 19.5"
© Patricia E. Ritter

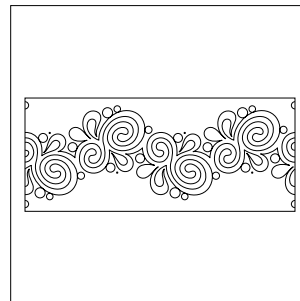

Marmalade
Design Size - 9.75" x 28"
© Patricia E. Ritter & Leisha Farnsworth

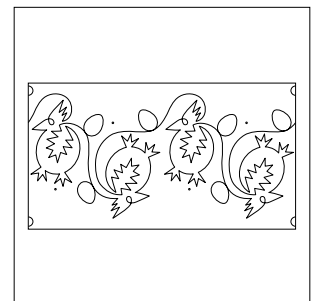

Mary's Funky Chicken
Design Size - 10" x 21.5"
© Mary Eddy / Jelly Bean

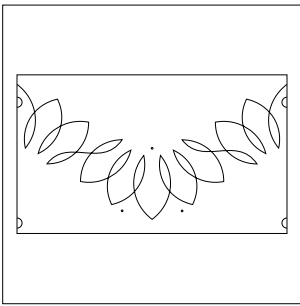

Maui
Design Size - 10" x 20"
© Sarah Ann Myers

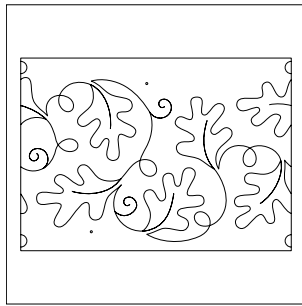

Maureen's Oakleaf - Set
Set Size - 10" x 33"
© Maureen Foster / Humble Bee Quilting

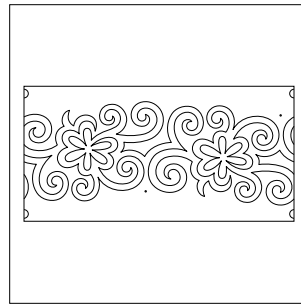

May Flower
Design Size - 9" x 23.5"
© Patricia E. Ritter

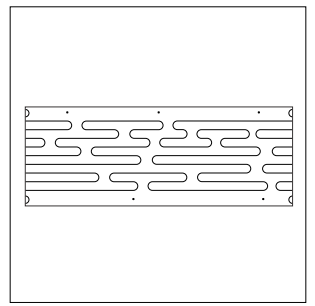

Maze
Design Size - 7" x 27"
© Patricia E. Ritter & Jessica Schick

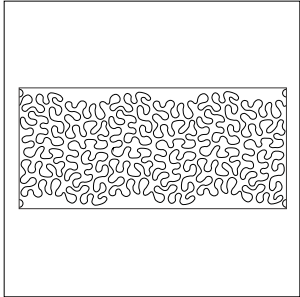

Meandering
Design Size - 11" x 26"
© R&S Designs

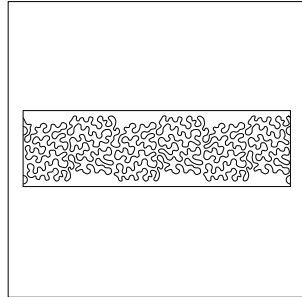

Meandering - Petite
Design Size - 5.75" x 23.75"
© R&S Designs

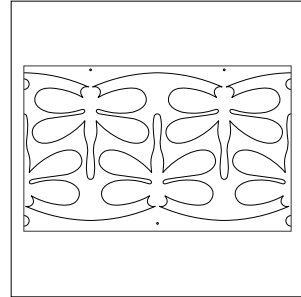

Meandering Dragonfly - Border
Single Row Size - 7.5" x 19"
© Laura Estes

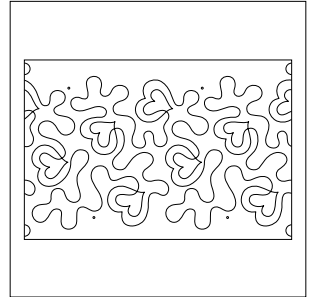

Meandering Hearts - Set
Set Size - 10" x 35"
© Dave Hudson

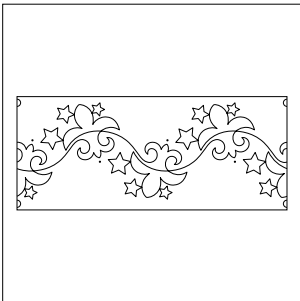

Medal of Honor
Design Size - 10" x 28"
© Patricia E. Ritter

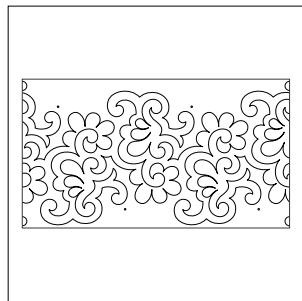

Melange
Design Size - 11" x 22"
© Patricia E. Ritter

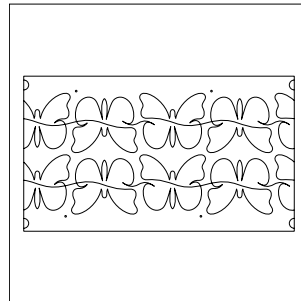

Melissa's Flutter
Single Row Size - 4.5" x 20.5"
© Melissa Kelley

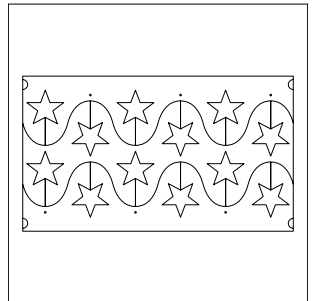

Melissa's Groovy Star
Single Row Size - 5" x 20.5"
© Melissa Kelley

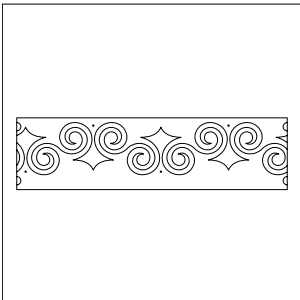

Melissa's Scrolls
Design Size - 4.75" x 24.5"
© Melissa Kelley

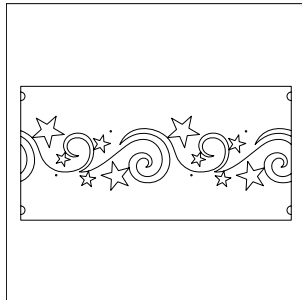

Melissa's Wish Upon A Star
Design Size - 6.5" x 23.75"
© Melissa Kelley

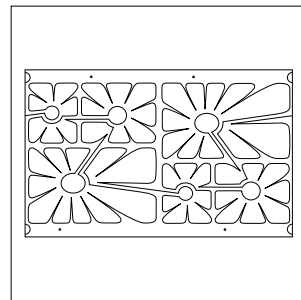

Mellow Yellow
Design Size - 10.5" x 20"
© Patricia E. Ritter

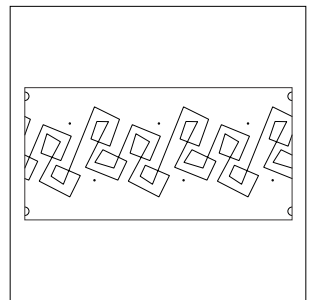

Memphis Blues
Design Size - 8" x 23.75"
© Sarah Ann Myers

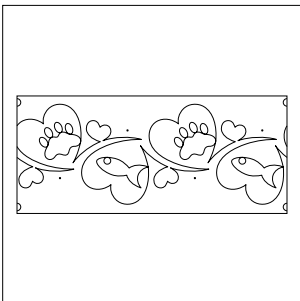

Meowz - Cat Treats
Design Size - 10" x 27"
© Melonie J. Caldwell

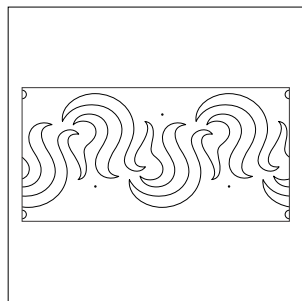

Mercury
Design Size - 10" x 23.5"
© Sarah Ann Myers

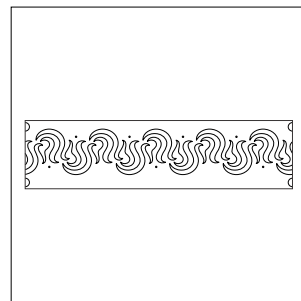

Mercury - Petite
Design Size - 4" x 23.5"
© Sarah Ann Myers

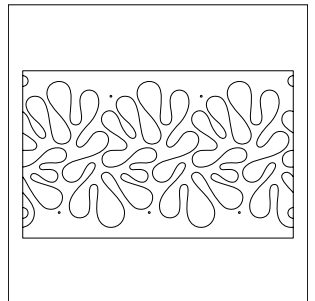

Mermaid Fingers
Design Size - 10.25" x 19"
© Apricot Moon Designs

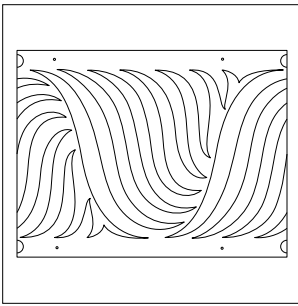

Mesmerize - Set
Set Size - 10" x 32"

© Patricia E. Ritter & Claudia Pfeil

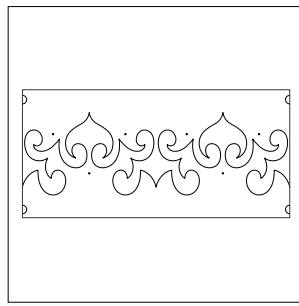

Mesopotamia
Design Size - 7.25" x 23.5"

© Hermione Agee

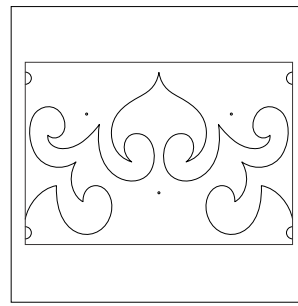

Mesopotamia - Grande - Set
Set Size - 10" x 33"

© Hermione Agee

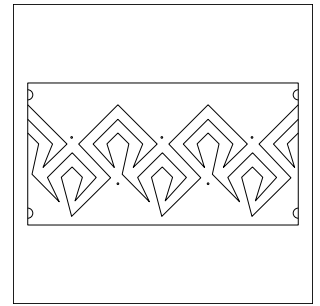

Miami Beach
Design Size - 8.25" x 20"

© Melonie J. Caldwell

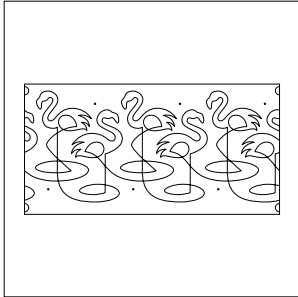

Miami Mingo
Design Size - 10" x 23"

© Melonie J. Caldwell

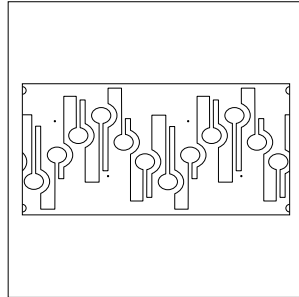

Mid Century
Design Size - 10" x 22"

© Patricia E. Ritter

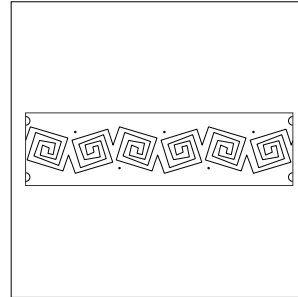

Midway - 1 Row
Design Size - 4" x 23"

© Patricia E. Ritter & Tracey Russell

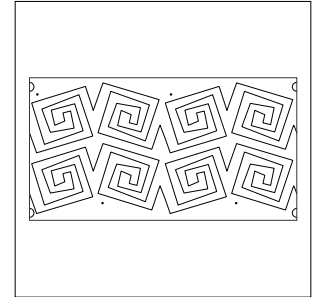

Midway - 2 Row
Single Row Size - 6" x 22.5"

© Patricia E. Ritter & Tracey Russell

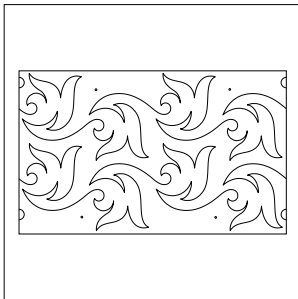

Mimosa
Single Row Size - 6.25" x 19.25"

© Patricia E. Ritter

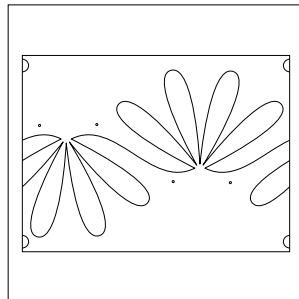

Ming - Set
Set Size - 10" x 32"

© Sarah Ann Myers

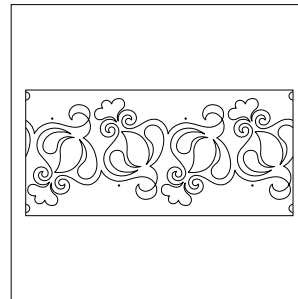

Miss Fancy
Design Size - 10" x 25"

© Naomi Hynes

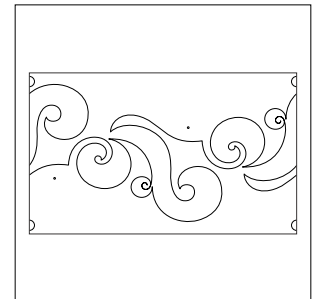

Misty Morning
Design Size - 10" x 19.5"

© Hermione Agee

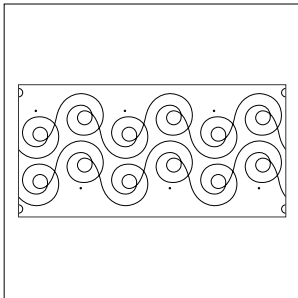

Mod Dot
Single Row Size - 5.75" x 23.75"

© Patricia E. Ritter

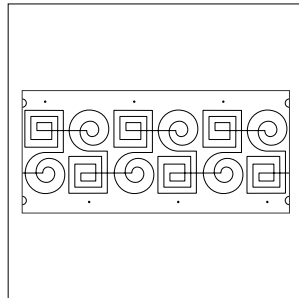

Modern Greek Key
Design Size - 7.5" x 24"

© Jessica Schick

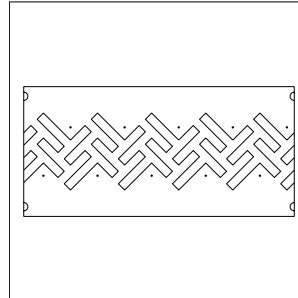

Modern Herringbone
Design Size - 7" x 24.5"

© Mel St. Clair

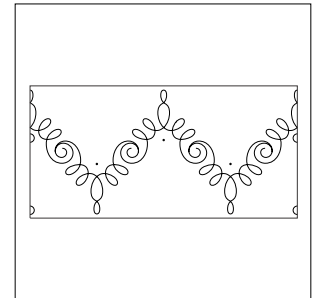

Modern Lace
Design Size - 11" x 23.75"

© Jessica Schick

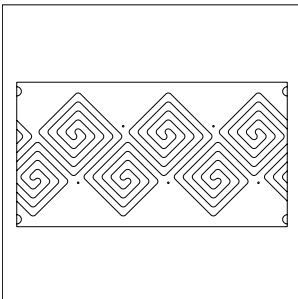

Modern Meander
Design Size - 10" x 22"

© Beany Girl Quilts

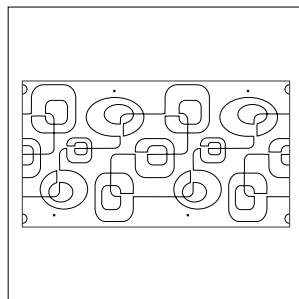

Modern Squares
Design Size - 11" x 21.5"

© Denise Schillinger

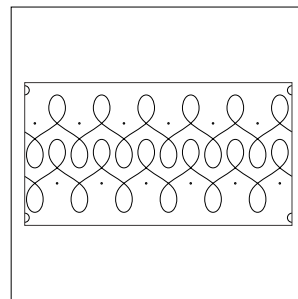

Modern Twist
Single Row Size - 6" x 22"

© Patricia E. Ritter

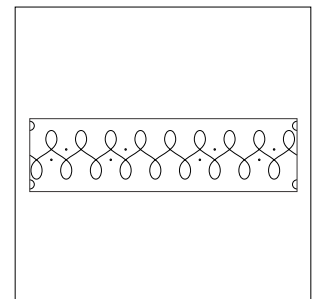

Modern Twist - Petite
Design Size - 4" x 22"

© Patricia E. Ritter

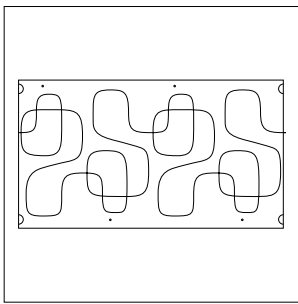

Modernish #1
Design Size - 10" x 21"
© Barbara Becker

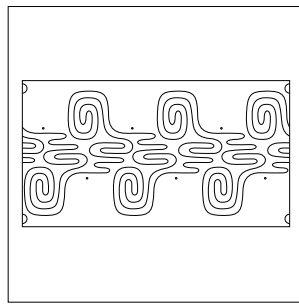

Modernish #2
Design Size - 10" x 21.5"
© Barbara Becker

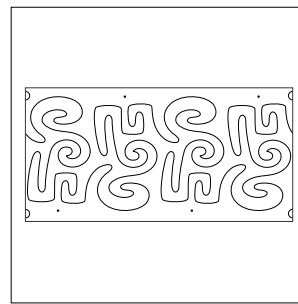

Modernish #3
Design Size - 10" x 23.5"
© Barbara Becker

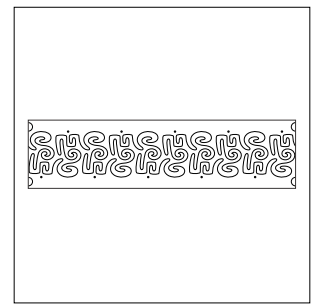

Modernish #3 - Petite
Design Size - 4" x 23.5"
© Barbara Becker

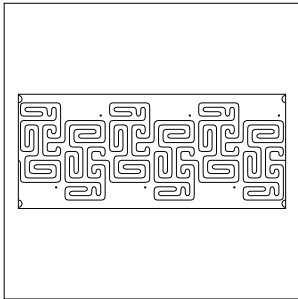

Modernish #4
Design Size - 10" x 27.5"
© Barbara Becker

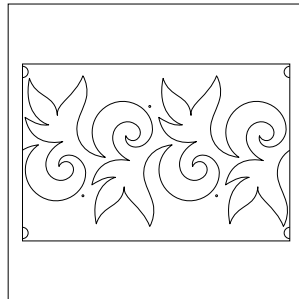

Mojito - Set
Set Size - 10" x 35.5"
© Melonie J. Caldwell

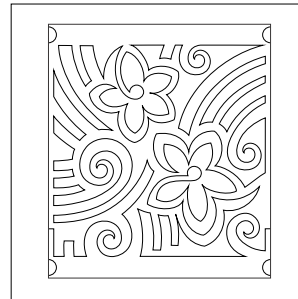

Mola #1
Design Size - 10.5" x 10"
© Patricia E. Ritter

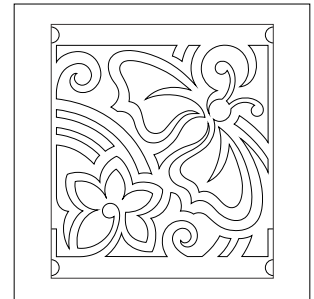

Mola #2
Design Size - 10.5" x 10"
© Patricia E. Ritter

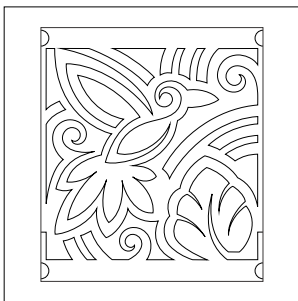

Mola #3
Design Size - 10.5" x 10"
© Patricia E. Ritter

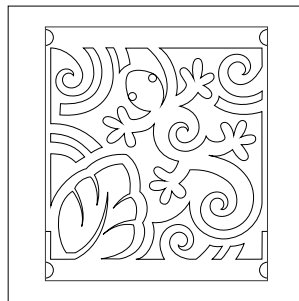

Mola #4
Design Size - 10.5" x 10"
© Patricia E. Ritter

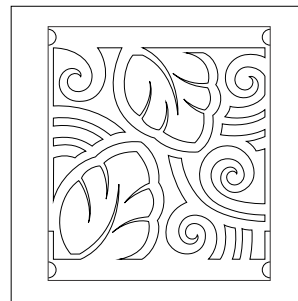

Mola #5
Design Size - 10.5" x 10"
© Patricia E. Ritter

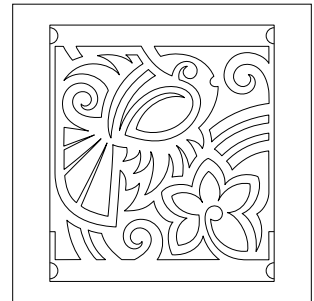

Mola #6
Design Size - 10.5" x 10"
© Patricia E. Ritter

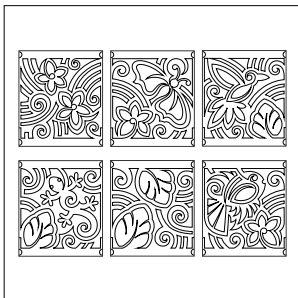

Mola Set
Design Size - 10.5" x 10"
© Patricia E. Ritter

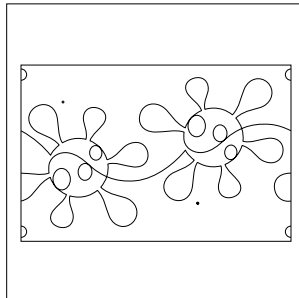

Molecules - Set
Set Size - 10" x 36"
© Patricia E. Ritter

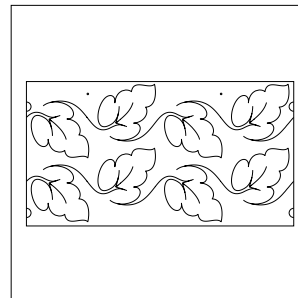

Monstera
Single Row Size - 6" x 21.75"
© Patricia E. Ritter

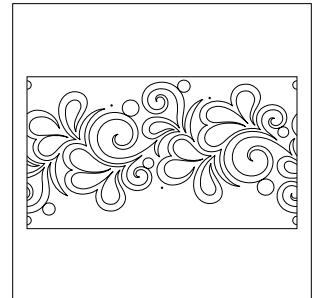

Moulin Rouge
Design Size - 12" x 24.5"
© Patricia E. Ritter

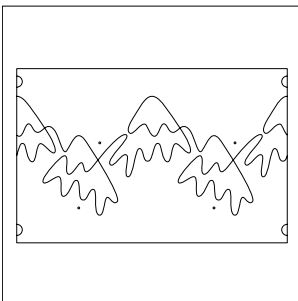

Mountain High
Design Size - 8" x 18.25"
© Willow Leaf Designs

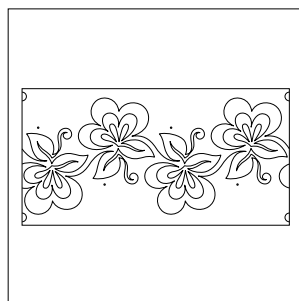

Moxie
Design Size - 10" x 23"
© Patricia E. Ritter & Leisha Farnsworth

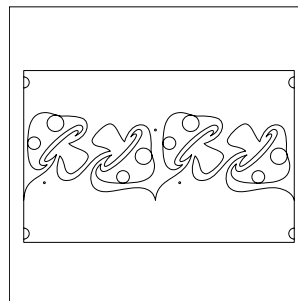

Mushroom Patch
Design Size - 6" x 18.5"
© Beany Girl Quilts

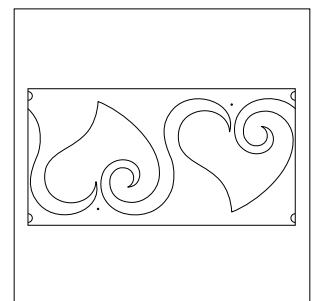

My Curly Heart - Sashing
Design Size - 10" x 23"
© Naomi Hynes

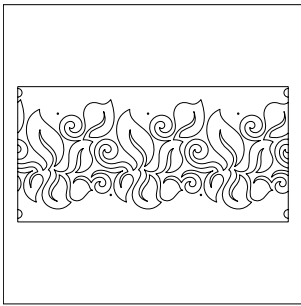

Naomi's Leafy Curly
Design Size - 9.5" x 23.5"
© Naomi Hynes

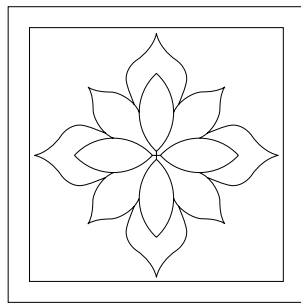

Nell's Flower - Block
Design Size - 9" x 9"
© R&S Designs

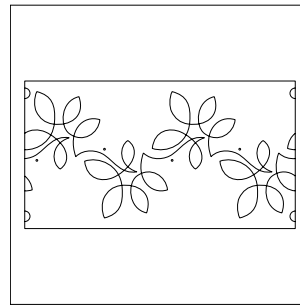

Netting #1
Design Size - 9" x 19.25"
© Sarah Ann Myers

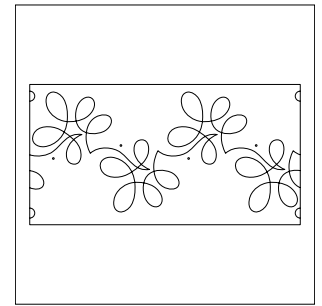

Netting #2
Design Size - 9" x 20.25"
© Sarah Ann Myers

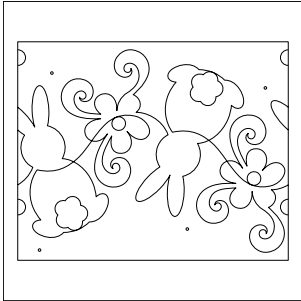

Niblet - Set
Set Size - 9.75" x 26"
© Melonie J. Caldwell

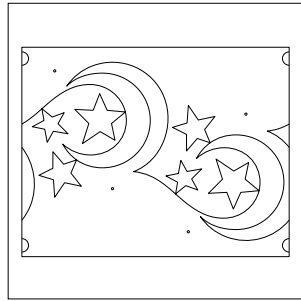

Night Sky - Set
Set Size - 10" x 30"
© Sarah Ann Myers

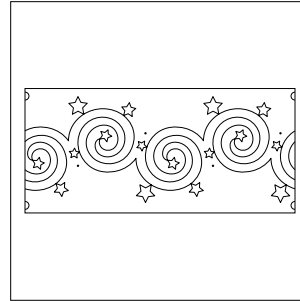

Nightlight
Design Size - 10" x 25.5"
© Patricia E. Ritter & Marybeth O'Halloran

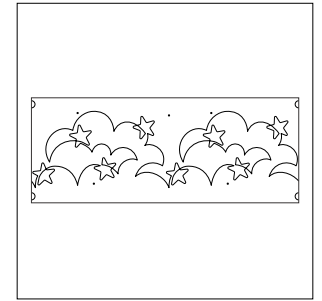

Nighty Night
Design Size - 8" x 28"
© Jessica Schick

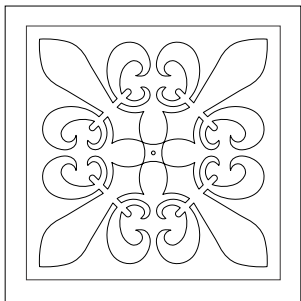

Nora's Scarab - Block
Design Size - 7.75" x 7.75"
© R&S Designs

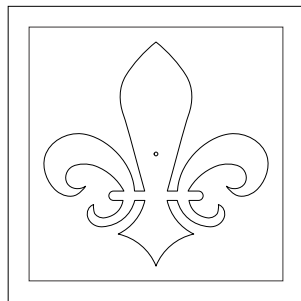

Nora's Scarab - Motif
Design Size - 7.5" x 7.5"
© R&S Designs

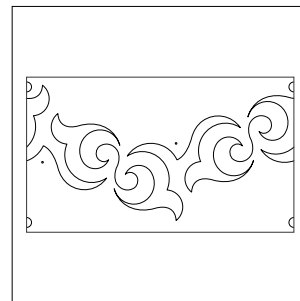

North Wind - Grande
Design Size - 10.25" x 20.25"
© Hermione Agee

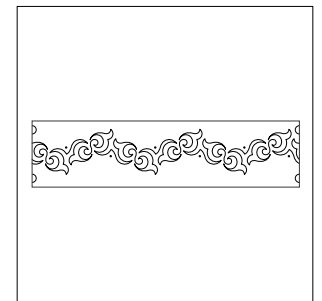

North Wind - Petite - 1 Row
Design Size - 4" x 24.25"
© Hermione Agee

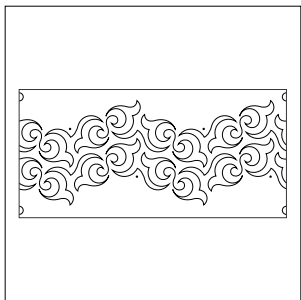

North Wind - Petite - 2 Row
Single Row Size - 6" x 24.5"
© Hermione Agee

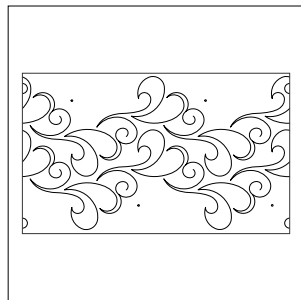

Nouveau Feathers
Single Row Size - 7.5" x 20"
© Hermione Agee

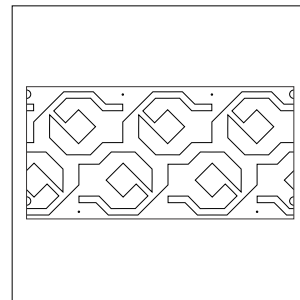

Nutz and Boltz
Single Row Size - 5.5" x 23.75"
© Patricia E. Ritter & Marybeth O'Halloran

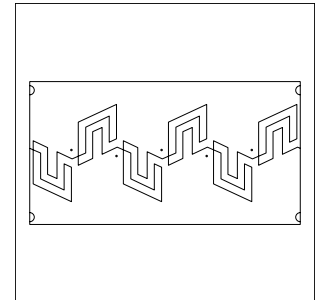

Off the Wall
Design Size - 8" x 22.25"
© Patricia E. Ritter & Leisha Farnsworth

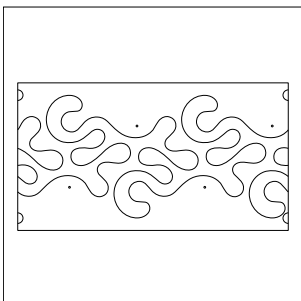

Oil and Water
Design Size - 8.75" x 19.25"
© Melonie J. Caldwell

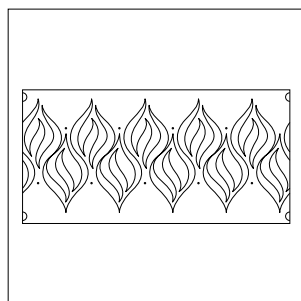

Onion Skin
Design Size - 10" x 23.5"
© Jessica Schick

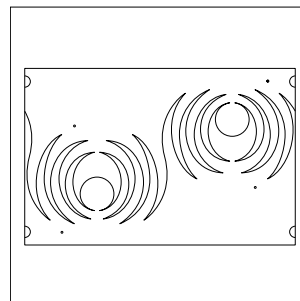

Orb
Design Size - 9" x 18"
© Sarah Ann Myers

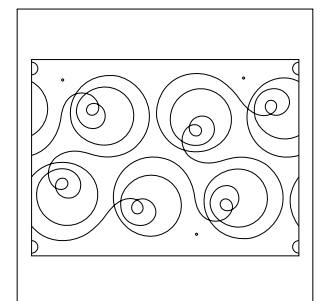

Orbit Around the Sun - Set
Set Size - 10" x 32"
© Patricia E. Ritter & Sarah Ann Myers

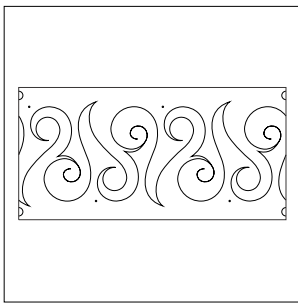

Organza
Design Size - 9.25" x 23.75"

© Patricia E. Ritter & Marybeth O'Halloran

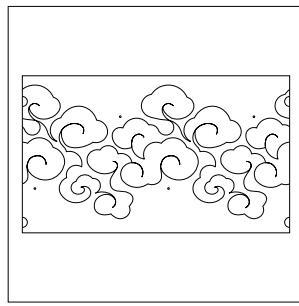

Oriental Cloud
Design Size - 10" x 20"

© Keryn Emmerson

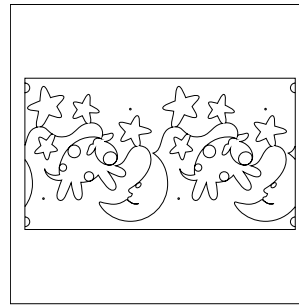

Over the Moon
Design Size - 10.5" x 21"

© Patricia E. Ritter

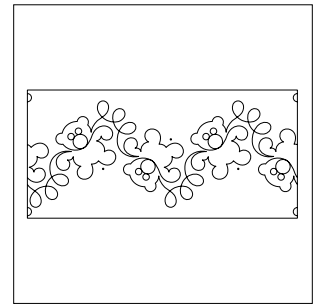

Ozzy
Design Size - 9.75" x 24.75"

© Patricia E. Ritter & Jeffery Schillinger

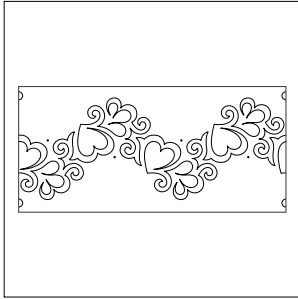

P.S. I Love You
Design Size - 9.5" x 25"

© Patricia E. Ritter

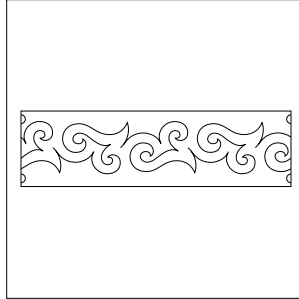

Pageboy - 1 Row
Design Size - 4.5" x 23.25"

© Patricia E. Ritter

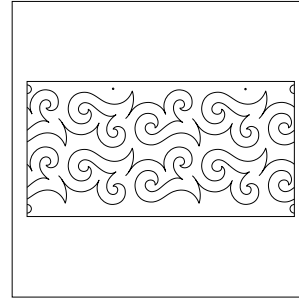

Pageboy - 2 Row
Single Size - 5" x 23.25"

© Patricia E. Ritter

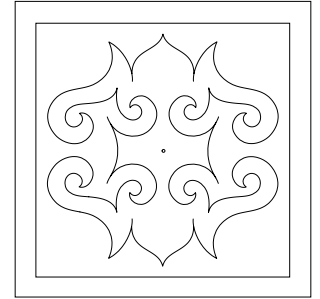

Pageboy - Block
Design Size - 10" x 10"

© Patricia E. Ritter

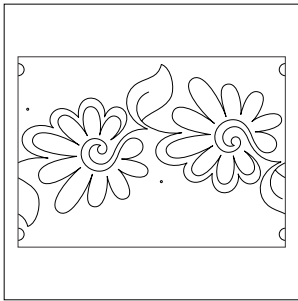

Painted Daisies - Set
Set Size - 10" x 33"

© Patricia E. Ritter & Valerie Smith

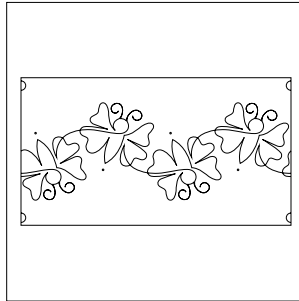

Painted Lady
Design Size - 7.75" x 21.5"

© Patricia E. Ritter & Jeffery Schillinger

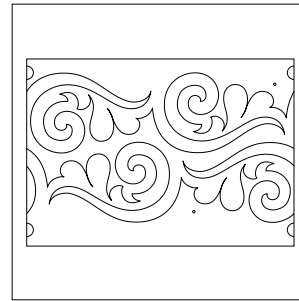

Paisley - Set
Single Row Size - 4.5" x 15"

© Patricia E. Ritter

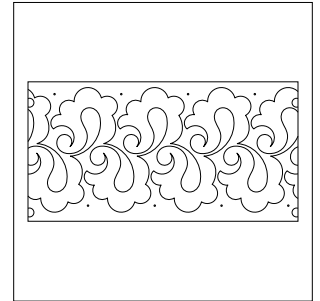

Paisley Curls
Design Size - 10.5" x 22.75"

© Keryn Emmerson

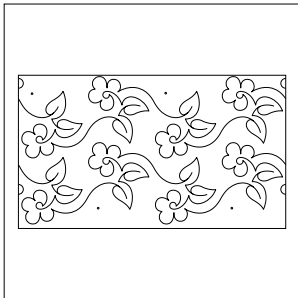

Pansies
Single Row Size - 6.25" x 20.5"

© Patricia E. Ritter

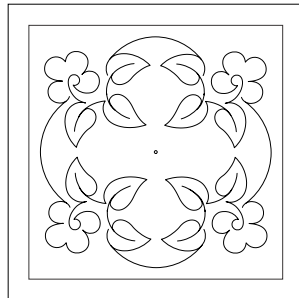

Pansies - Block
Design Size - 10" x 10"

© Patricia E. Ritter

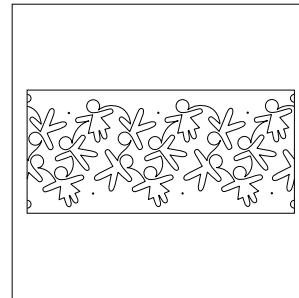

Paper Dolls
Design Size - 10.25" x 25.5"

© Patricia E. Ritter

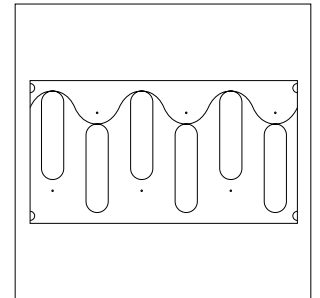

Paper Lanterns
Design Size - 10" x 22"

© Sarah Ann Myers

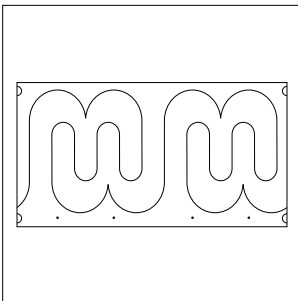

Paperclips
Design Size - 10" x 22"

© Judy Borger

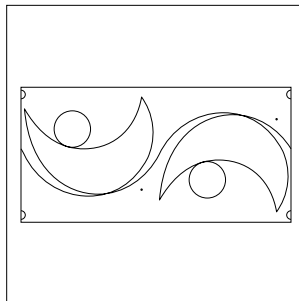

Parabolic - Petite
Design Size - 10" x 23.5"

© Patricia E. Ritter & Melonie J. Caldwell

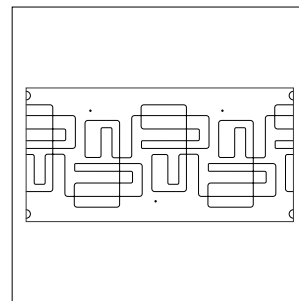

Paradox
Design Size - 9" x 23.5"

© Megan Hahn

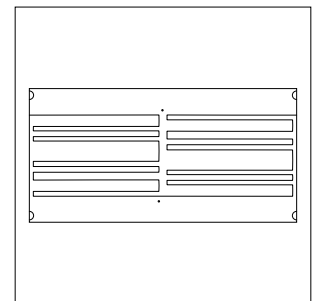

Parallel Lines
Design Size - 7.25" x 23.5"

© Patricia E. Ritter

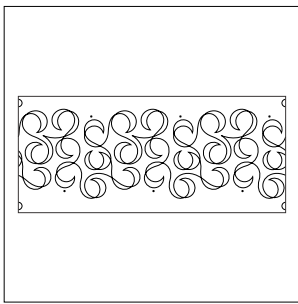

Party Streamers
Design Size - 9" x 27"
© Jessica Schick

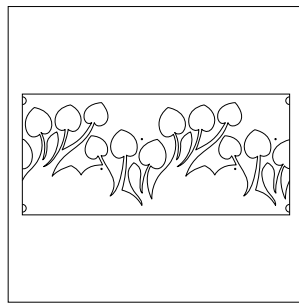

Pasture
Design Size - 10" x 26"
© Naomi Hynes

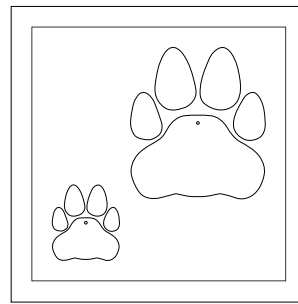

Paw Print - Block
Design Sizes - 3.5" & 7"
© R&S Designs

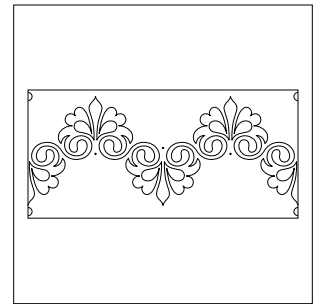

Penelope
Design Size - 10" x 24.75"
© Patricia E. Ritter & Denise Schillinger

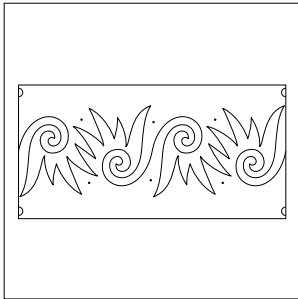

Penny Banger
Design Size - 8" x 23.5"
© Naomi Hynes

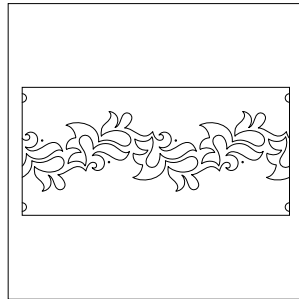

Perfume
Design Size - 7" x 23.5"
© Hermione Agee

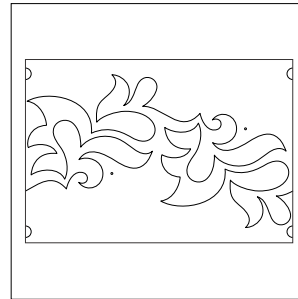

Perfume - Grande - Set
Set Size - 10" x 35"
© Hermione Agee

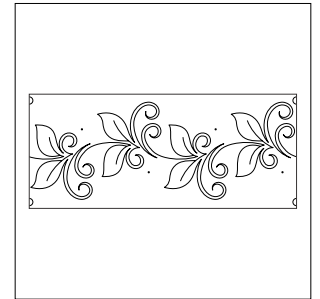

Pergola
Design Size - 10" x 27.5"
© Patricia E. Ritter & Tracey Russell

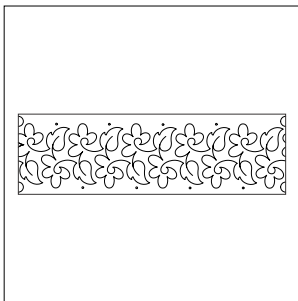

Periwinkles - Petite
Design Size - 5" x 20"
© Patricia E. Ritter

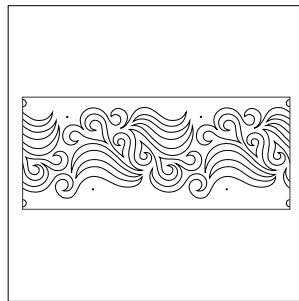

Petal Flambé
Design Size - 9.5" x 28"
© Mary Eddy / Jelly Bean

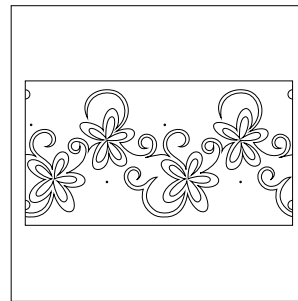

Petal Pushers
Design Size - 10.25" x 21.75"
© Lisa H. Calle

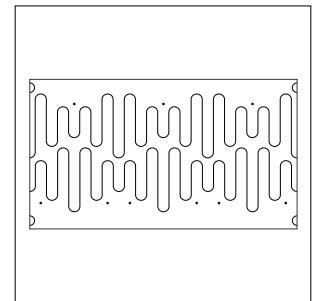

Photon Wave #2
Single Row Size - 5" x 21"
© Jessica Schick

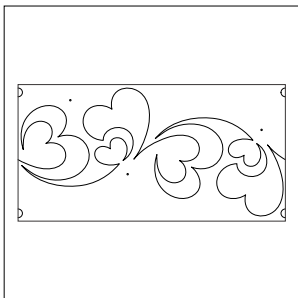

Pieces of My Heart
Design Size - 11" x 23"
© Melonie J. Caldwell

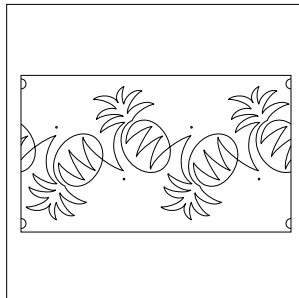

Piña Colada
Design Size - 10" x 20.25"
© Melonie J. Caldwell

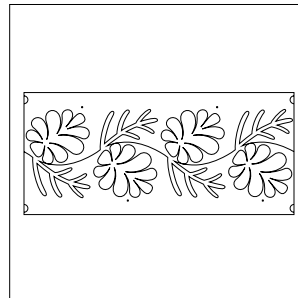

Pine Cone Sprig - Border
Design Size - 8.5" x 26"
© Maureen Foster / Humble Bee Quilting

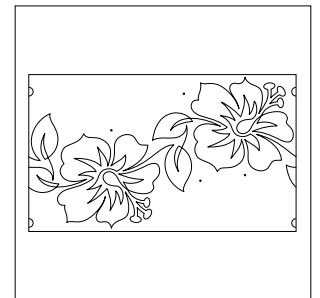

Pink Hibiscus
Design Size - 13" x 23"
© Sarah Ann Myers

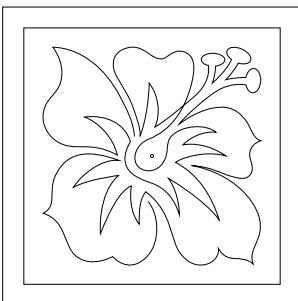

Pink Hibiscus - Block #3
Design Size - 8.5" x 8.5"
© Sarah Ann Myers

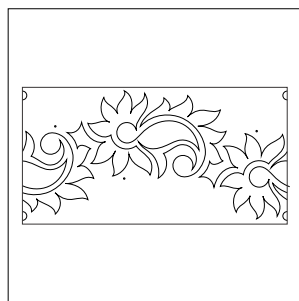

Pink Paisley
Design Size - 11" x 22.75"
© Patricia E. Ritter

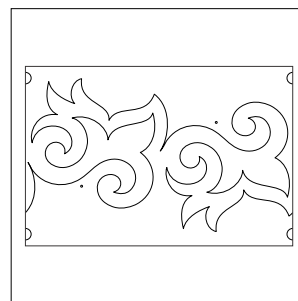

Pipeline - Grande - Set
Set Size - 10" x 35"
© Patricia E. Ritter

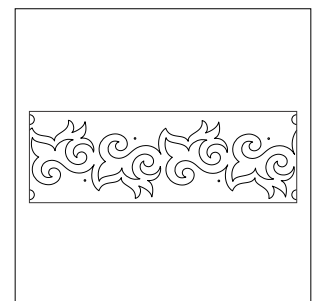

Pipeline - Petite - 1 Row
Design Size - 6" x 20.5"
© Patricia E. Ritter

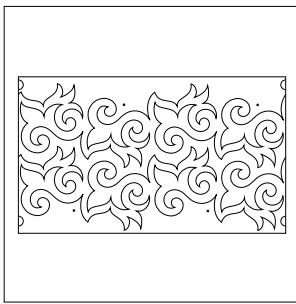

Pipeline - Petite - 2 Row
Design Size - 6.5" x 20.5"

© Patricia E. Ritter

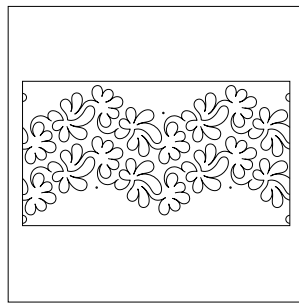

Plumbago
Single Row Size - 7.25" x 25"

© Patricia E. Ritter

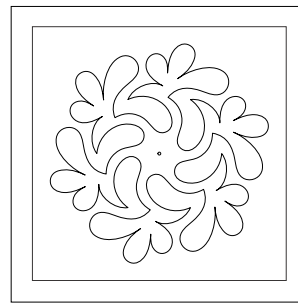

Plumbago - Block
Design Size - 9.5" x 9.5"

© Patricia E. Ritter

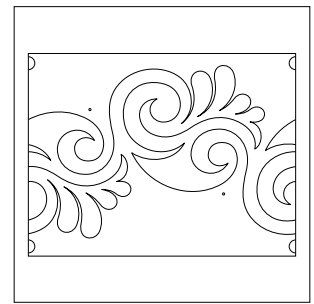

Plume - Set
Set Size - 10" x 31"

© Hermione Agee

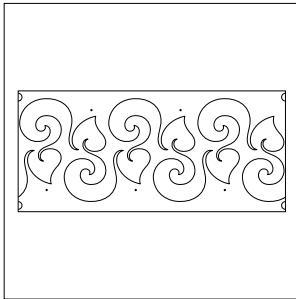

Plump
Design Size - 10" x 26"

© Hermione Agee

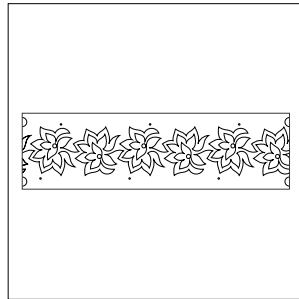

Poinsettia
Design Size - 4" x 22"

© Patricia E. Ritter

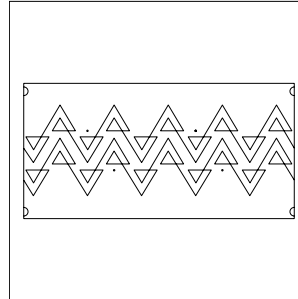

Point
Design Size - 5" x 23.5"

© Leisha Farnsworth

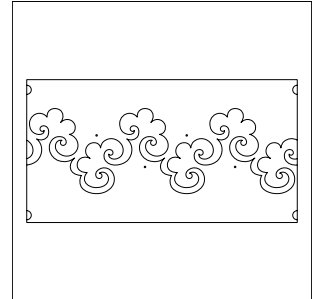

Popcorn
Design Size - 7" x 22.25"

© Willow Leaf Designs

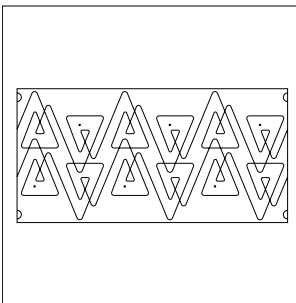

Prism
Single Row Size - 7" x 23.75"

© Melonie J. Caldwell

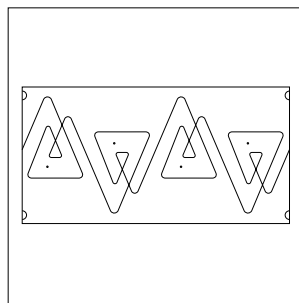

Prism - Grande
Design Size - 10" x 23"

© Melonie J. Caldwell

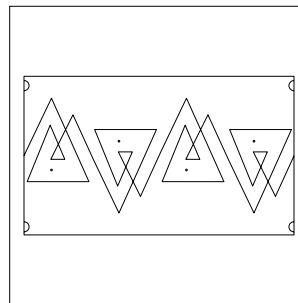

Prism - Peaked
Design Size - 8.5" x 20"

© Melonie J. Caldwell

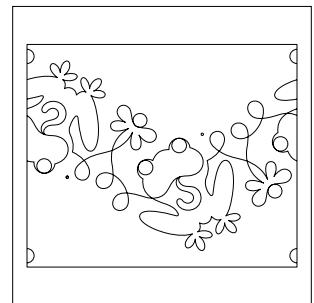

Puddle Jumper - Set
Set Size - 10" x 28.5"

© Patricia E. Ritter & Jeffery Schillinger

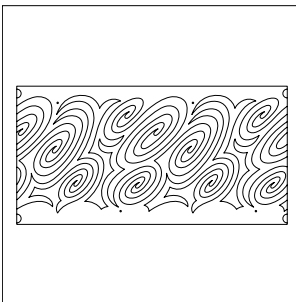

Puddle Swirls
Design Size - 10" x 23"

© Kalynda Grant

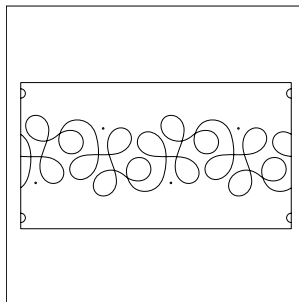

Pulling Thread
Design Size - 6.5" x 21.75"

© Melonie J. Caldwell & Tia L. Kennard

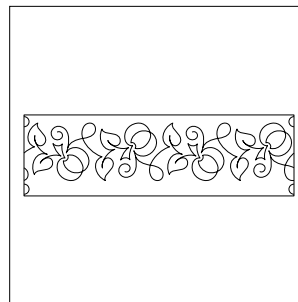

Pumpkin Patch - 1 Row
Design Size - 4.25" x 20"

© Patricia E. Ritter

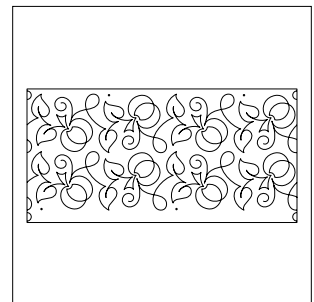

Pumpkin Patch - 2 Row
Single Row Size - 5.25" x 23.75"

© Patricia E. Ritter

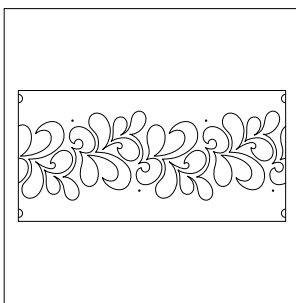

Punk Feathers
Design Size - 8" x 24"

© Hermione Agee

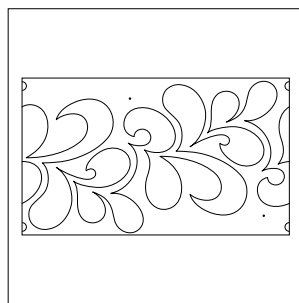

Punk Feathers - Grande
Design Size - 13" x 23"

© Hermione Agee

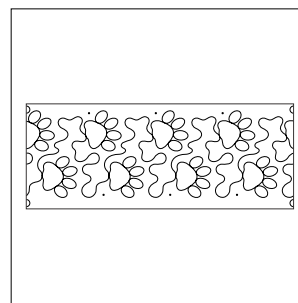

Puppy Paws
Design Size - 9" x 28"

© Jessica Schick

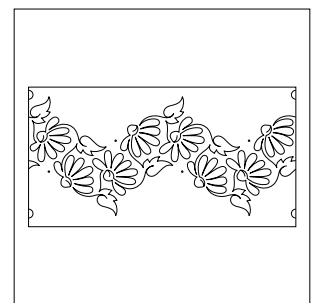

Purple Meadow
Design Size - 10" x 22.5"

© Patricia E. Ritter

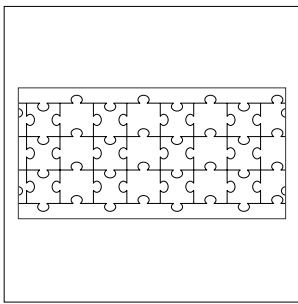

Puzzle
Design Size - 10.5" x 24"
© R&S Designs

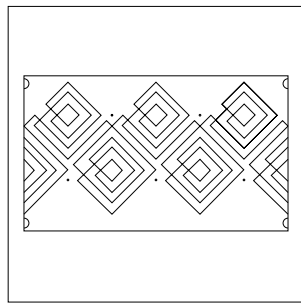

Quagmire
Design Size - 10" x 20"
© Jessica Schick

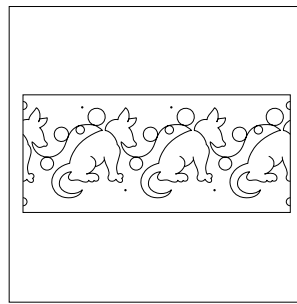

Quilting 4 Pawz
Design Size - 8.5" x 25"
© Patricia E. Ritter

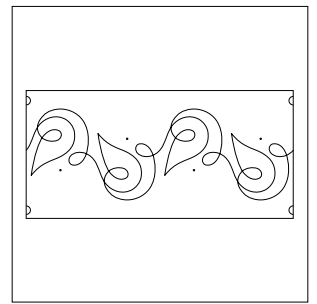

Quirky
Design Size - 8" x 23.5"
© Sarah Ann Myers

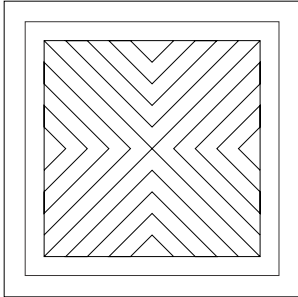

R&S Pattern 1 - Block
Design Size - 5" x 5"
© R&S Designs

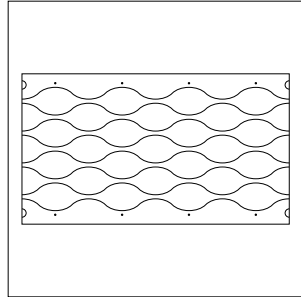

R&S Ripples
Double Row Size - 2.5" x 24"
© R&S Designs

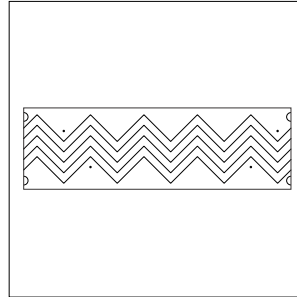

R&S Zig Zag #1
Single Row Size - 2.25" x 23"
© R&S Designs

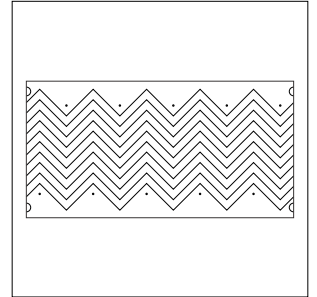

R&S Zig Zag #2
Single Row Size - 2.25" x 23"
© R&S Designs

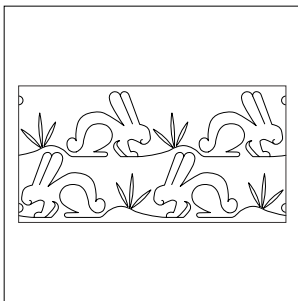

Rabbit
Single Row Size - 5.5" x 23"
© R&S Designs

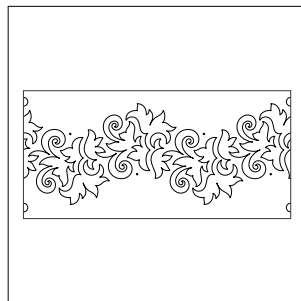

Radiance
Design Size - 8.75" x 23"
© Patricia E. Ritter

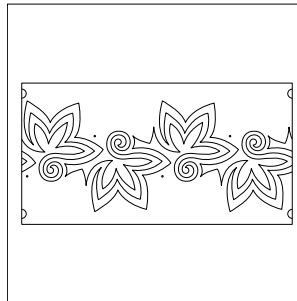

Radicchio
Design Size - 9.25" x 22.5"
© Patricia E. Ritter & Denise Schillinger

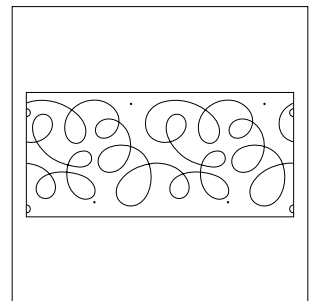

Ragtime
Design Size - 10" x 25.25"
© Patricia E. Ritter

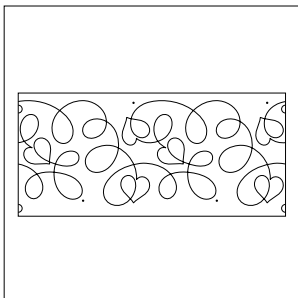

Ragtime - Hearts
Design Size - 10" x 25.5"
© Patricia E. Ritter

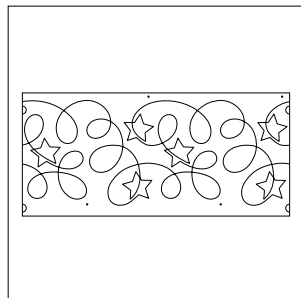

Ragtime - Stars
Design Size - 10" x 25.5"
© Patricia E. Ritter

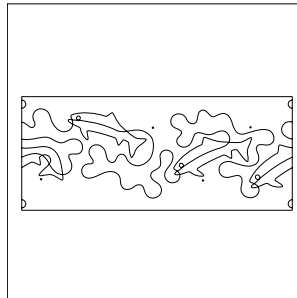

Rainbow Trout
Design Size - 8.25" x 25"
© Dave Hudson

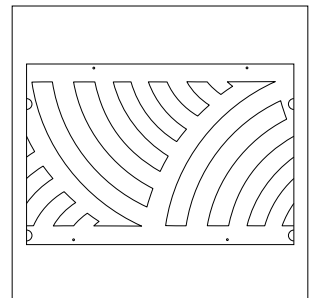

Rainbows - Set
Set Size - 10" x 37"
© Patricia E. Ritter & Tracey Russell

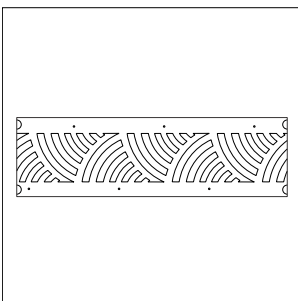

Rainbows - Petite
Design Size - 4" x 22.25"
© Patricia E. Ritter & Tracey Russell

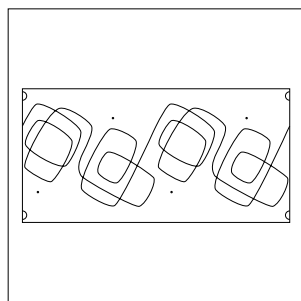

Ramble
Design Size - 9" x 23.5"
© Apricot Moon Designs

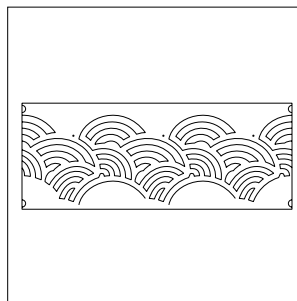

Random Clams
Design Size - 9.25" x 28"
© Jessica Schick

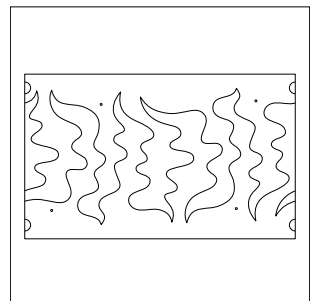

Rapids
Design Size - 8.75" x 17.25"
© Melonie J. Caldwell

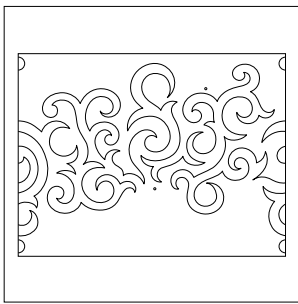

Raven's Claw - Set
Set Size - 10" x 31"
© Denise Schillinger

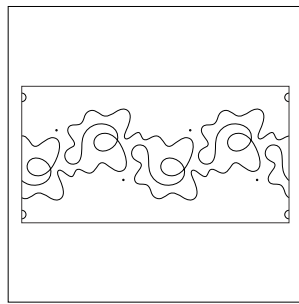

Ravioli
Design Size - 8" x 23.5"
© Sarah Ann Myers

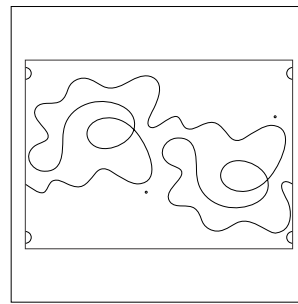

Ravioli - Grande - Set
Set Size - 10" x 34"
© Sarah Ann Myers

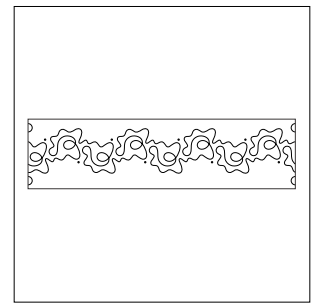

Ravioli - Petite
Design Size - 4" x 24"
© Sarah Ann Myers

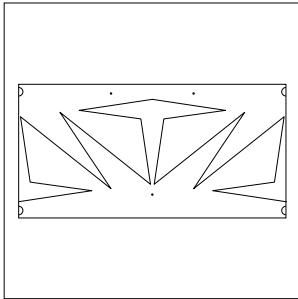

Razor
Design Size - 9" x 23.5"
© Sarah Ann Myers

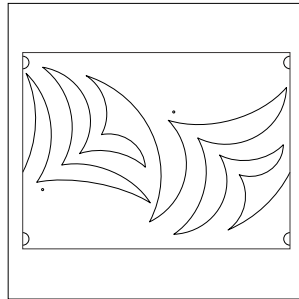

Razorshell - Set
Set Size - 10" x 32"
© Keryn Emmerson

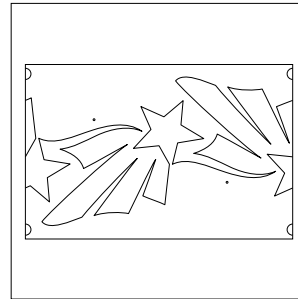

Red, White and Blue - Set
Set Size - 10" x 36"
© Patricia E. Ritter

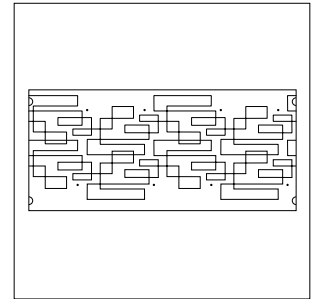

Retro Graphics #1
Design Size - 10" x 26"
© Sarah Ann Myers

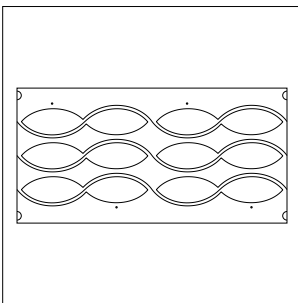

Retro Revolution - Sashing
Single Row Size - 2.75" x 23.5"
© Patricia E. Ritter

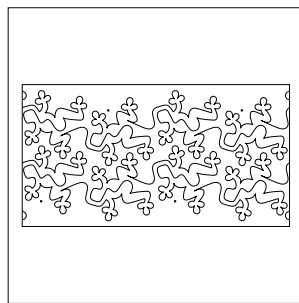

Ribbit
Single Row Size - 7" x 24.5"
© Patricia E. Ritter

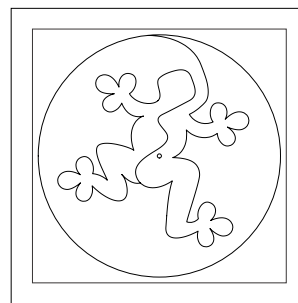

Ribbit - Block
Design Size - 10.5" x 10.5"
© Patricia E. Ritter

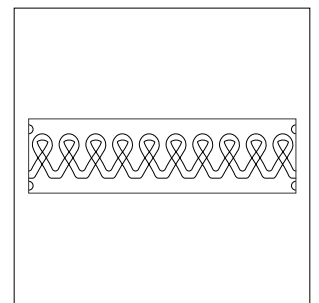

Ribbon
Design Size - 3.75" x 22.5"
© R&S Designs

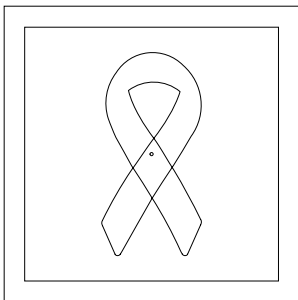

Ribbon - Motif
Design Size - 4" x 8"
© R&S Designs

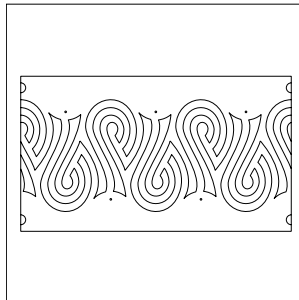

Ribbon Echo
Design Size - 8.5" x 20.5"
© Melissa Kelley

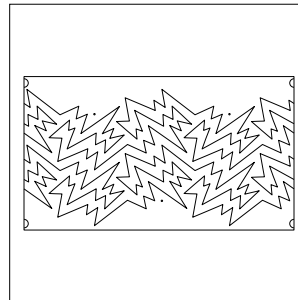

Ric Rac
Single Row Size - 7" x 23.75"
© Patricia E. Ritter

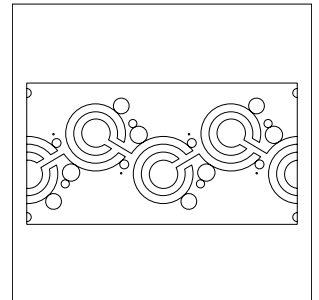

Ringlet
Design Size - 9.25" x 22.5"
© Patricia E. Ritter & Jeffery Schillinger

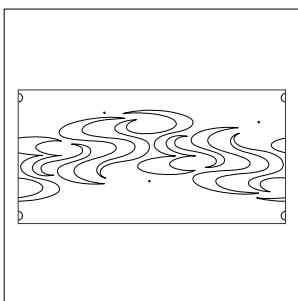

Ripples
Design Size - 8" x 23.5"
© Hermione Agee

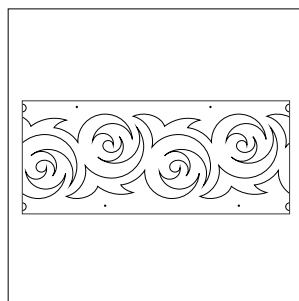

Riptide
Design Size - 8.25" x 26"
© Patricia E. Ritter

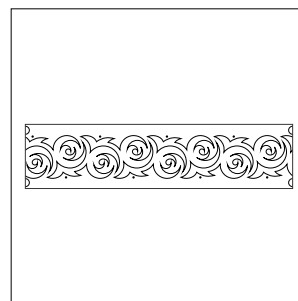

Riptide - Petite - 1 Row
Design Size - 4" x 25"
© Patricia E. Ritter

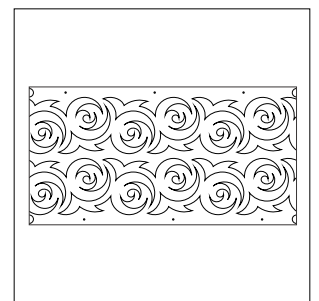

Riptide - Petite - 2 Row
Single Row Size - 5" x 23.75"
© Patricia E. Ritter

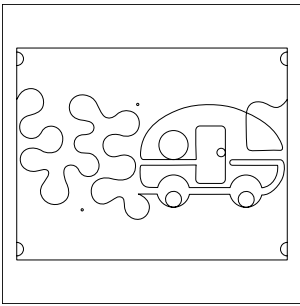

Road Trip - Cross Country - Set
Set Size - 7.25" x 30"
© Melonie J. Caldwell

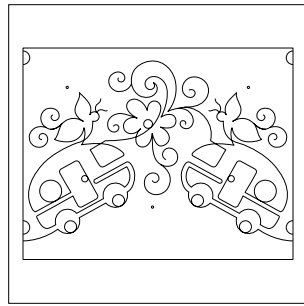

Road Trip - Grande - Set
Set Size - 10" x 30"
© Patricia E. Ritter & Melonie J. Caldwell

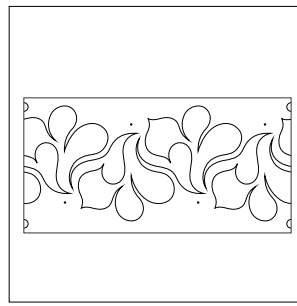

Rococo
Design Size - 10" x 23.25"
© Hermione Agee

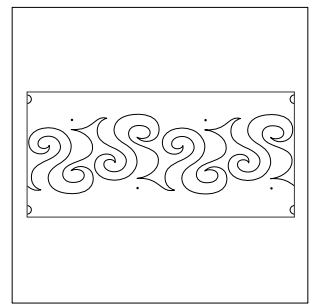

Roil
Design Size - 7" x 23.5"
© Hermione Agee

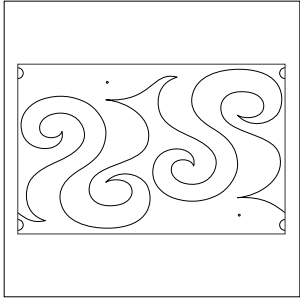

Roil - Grande - Set
Set Size - 11" x 37"
© Hermione Agee

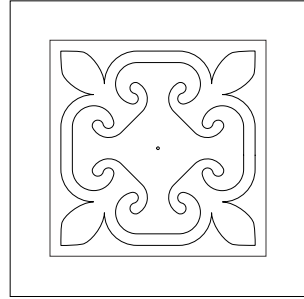

Roman Scroll Tile - Block - Small
Design Size - 5" x 5"
© R&S Designs

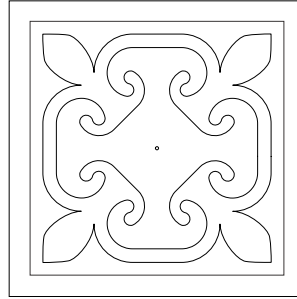

Roman Scroll Tile - Block - Large
Design Size - 9" x 9"
© R&S Designs

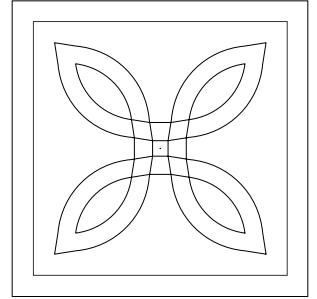

Rope - Block
Design Size - 6" x 6"
© R&S Designs

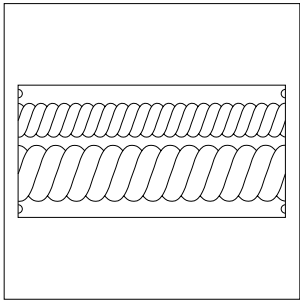

Rope - Double S
Design Sizes - 3" x 23.75" & 5" x 23.75"
© R&S Designs

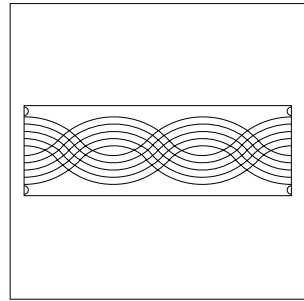

Rope - Medium
Design Size - 6" x 23.75"
© R&S Designs

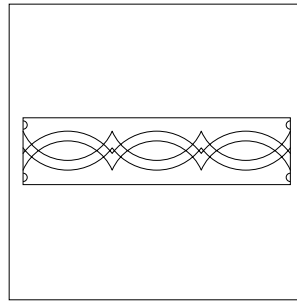

Rope - Pointed
Design Size - 3.5" x 24"
© R&S Designs

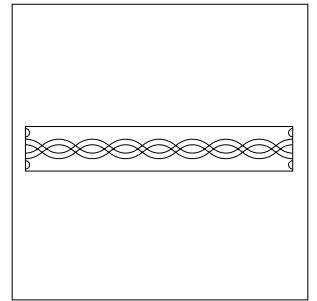

Rope - Small
Design Size - 1.75" x 24"
© R&S Designs

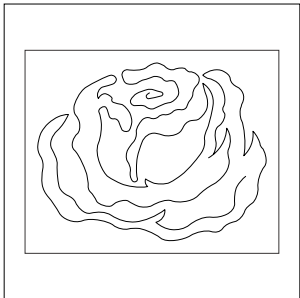

Rose - Motif
Design Size - 9" x 7"
© R&S Designs

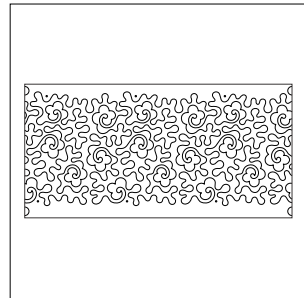

Rose Stipple
Design Size - 10" x 23.5"
© Laura Estes

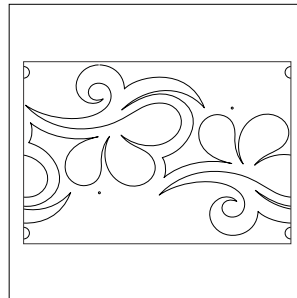

Ruffled - Set
Set Size - 11" x 34.5"
© Sarah Ann Myers

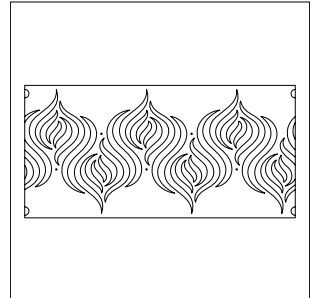

Russian Flames
Design Size - 11" x 24"
© Beany Girl Quilts

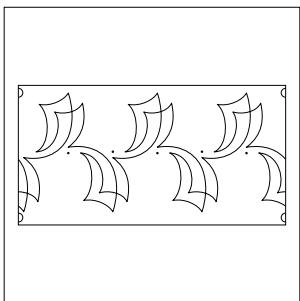

Sail On
Design Size - 10" x 22.5"
© Sarah Ann Myers

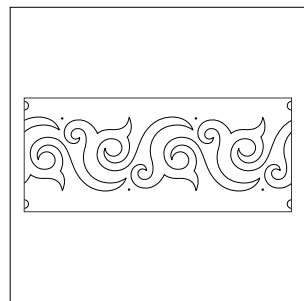

Sanibel
Design Size - 6.5" x 23.5"
© Melonie J. Caldwell

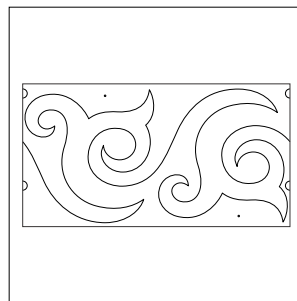

Sanibel - Grande
Design Size - 11" x 22"
© Melonie J. Caldwell

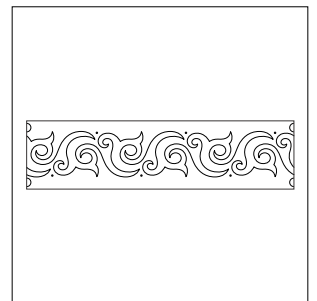

Sanibel - Petite
Design Size - 4" x 23.5"
© Melonie J. Caldwell

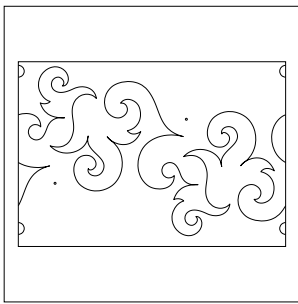

Santa Ana - Set
Set Size - 10.75" x 34"
© Patricia E. Ritter

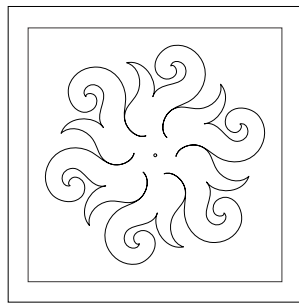

Santa Ana - Block
Design Size - 9.5" x 9.5"
© Patricia E. Ritter

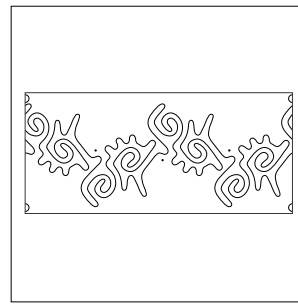

Santa Fe
Design Size - 10" x 26"
© Sarah Ann Myers

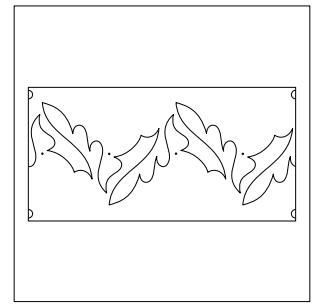

Sarah's Arabic
Design Size - 9" x 23.5"
© Sarah Ann Myers

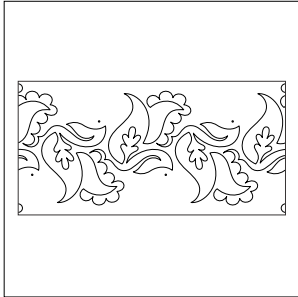

Sari
Design Size - 10" x 23.5"
© Hermione Agee

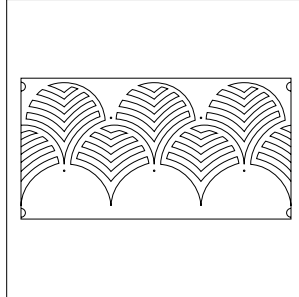

Sashiko
Design Size - 10.5" x 23"
© Patricia E. Ritter & Marybeth O'Halloran

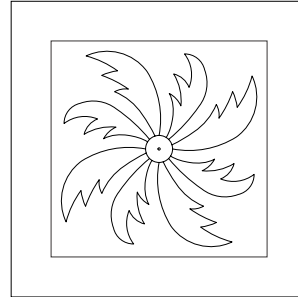

Saw Fan - Block - Small
Design Size - 5" x 5"
© R&S Designs

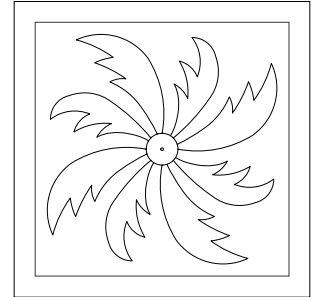

Saw Fan - Block - Large
Design Size - 10.75" x 10.75"
© R&S Designs

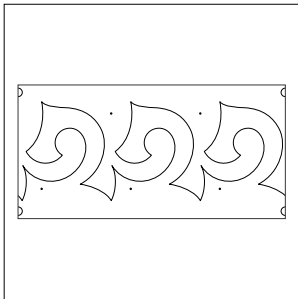

Saxon
Design Size - 8.75" x 23.5"
© Keryn Emmerson

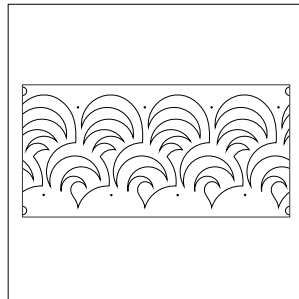

Scallop Grass
Design Size - 10" x 23.75"
© Hermione Agee

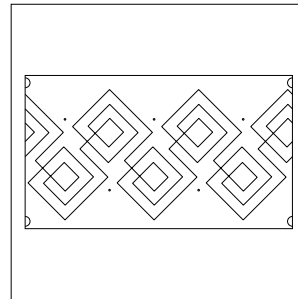

Scottish Plaid
Design Size - 10" x 20.5"
© Patricia E. Ritter

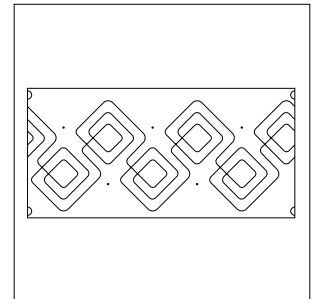

Scottish Plaid - Bias Cut
Design Size - 10" x 24.25"
© Patricia E. Ritter

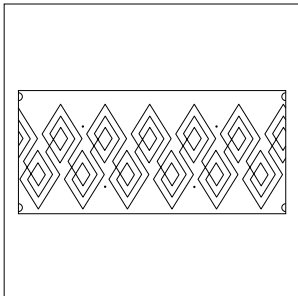

Scottish Plaid - Diamond Cut
Design Size - 10" x 25.5"
© Patricia E. Ritter

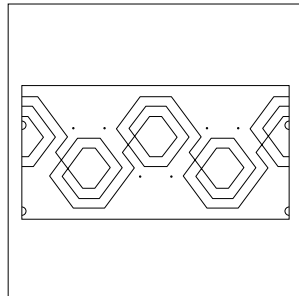

Scottish Plaid - Hexies
Design Size - 10" x 24"
© Patricia E. Ritter & Leisha Farnsworth

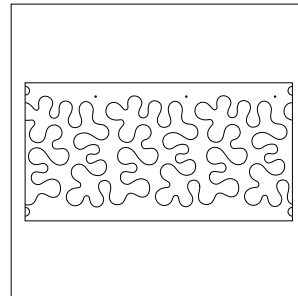

Scribbles
Design Size - 9.5" x 22.75"
© Patricia E. Ritter

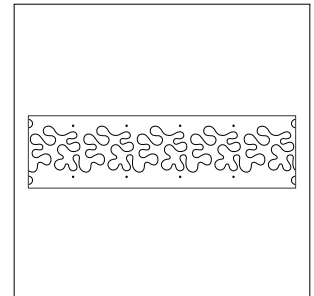

Scribbles - Petite
Design Size - 4.25" x 24"
© Patricia E. Ritter

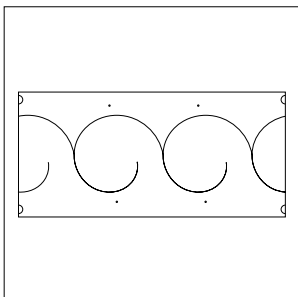

Scroll Frieze #2
Design Size - 6.75" x 23.5"
© Jessica Schick

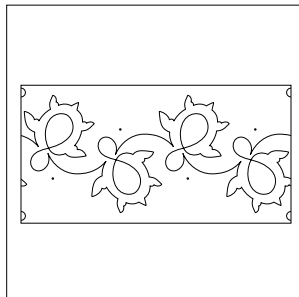

Sea Creatures - Turtles
Design Size - 10" x 23"
© Melonie J. Caldwell

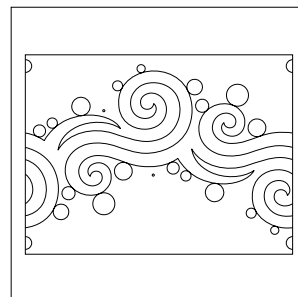

Seafoam - Set
Set Size - 10" x 31.5"
© Patricia E. Ritter

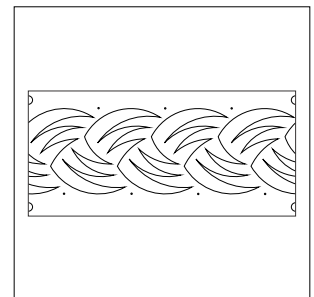

Seagrass Braid
Design Size - 7.5" x 23.5"
© Hermione Agee

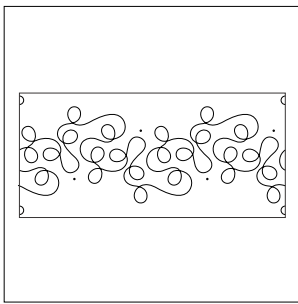

Seamless
Design Size - 8.5" x 23.75"
© Sarah Ann Myers

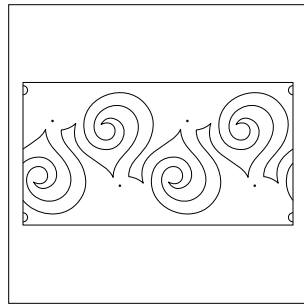

Seashell Swirl
Design Size - 10" x 22.25"
© Sarah Ann Myers

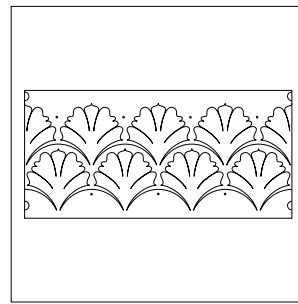

Sensu
Single Row Size - 5.25" x 23"
© Patricia E. Ritter

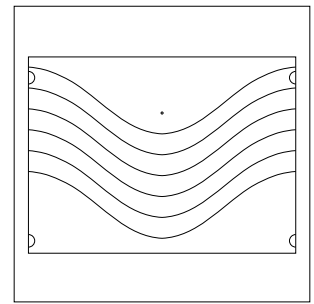

Serpentine - Set
Single Row Size - 4" x 16"
© Darlene Epp

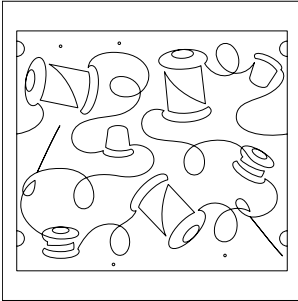

Sew Fun - Set
Set Size - 10.5" x 26.5"
© Maureen Foster / Humble Bee Quilting

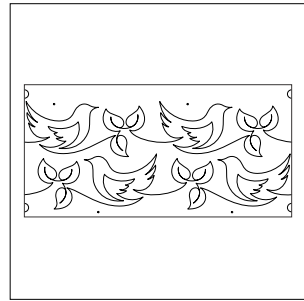

Sharon's Birds
Single Row Size - 5" x 23.75"
© R&S Designs

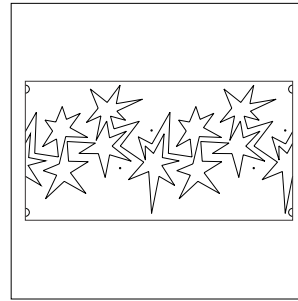

Shazam
Design Size - 12" x 25"
© Patricia E. Ritter

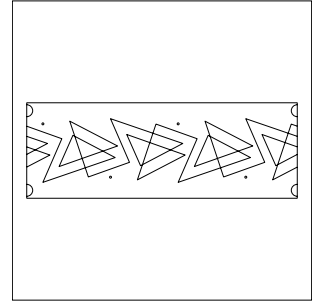

Sierra Nevada - Set
Set Size - 4" x 17"
© Sarah Ann Myers

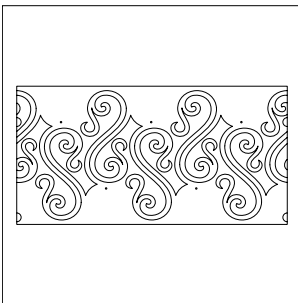

Sigrid
Design Size - 11" x 23"
© Jessica Schick

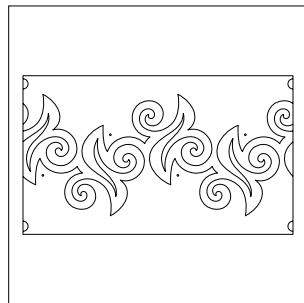

Silver
Design Size - 9" x 20"
© Patricia E. Ritter

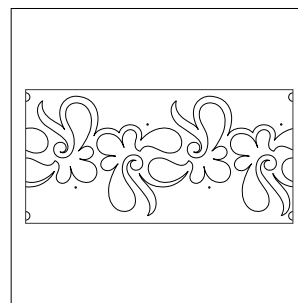

Silver Falls
Design Size - 10.5" x 23.5"
© Lisa H. Calle

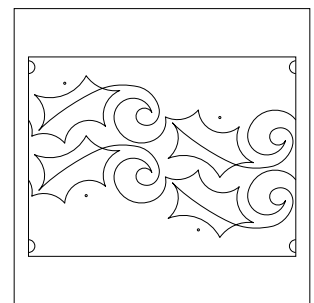

Simple Holly #1 - Set
Single Row Size - 6" x 15.75"
© Hermione Agee

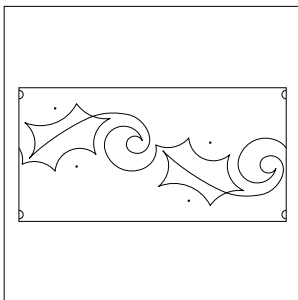

Simple Holly #2
Design Size - 9" x 23.5"
© Hermione Agee

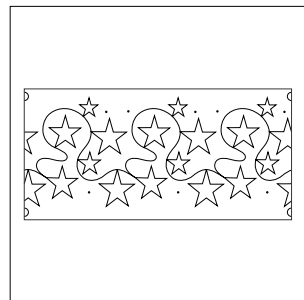

Simply Stars
Design Size - 9.75" x 24"
© Lisa H. Calle

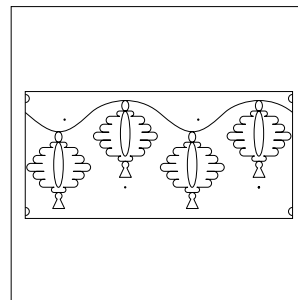

Sky Light
Design Size - 10" x 24.75"
© Melonie J. Caldwell

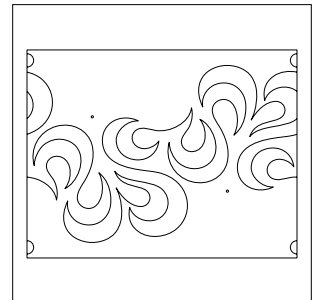

Slick - Set
Set Size - 10" x 30.5"
© Hermione Agee

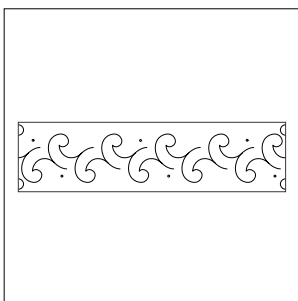

Snapdragons - Sashing
Design Size - 3.5" x 19.25"
© Patricia E. Ritter

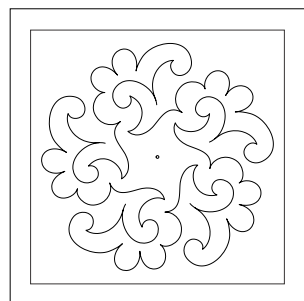

Snapdragons - Block #1
Design Size - 10.5" x 10.5"
© Patricia E. Ritter

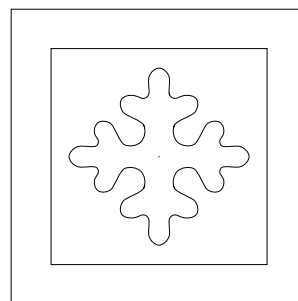

Snow Flake - Block - Small
Design Size - 7" x 7"
© R&S Designs

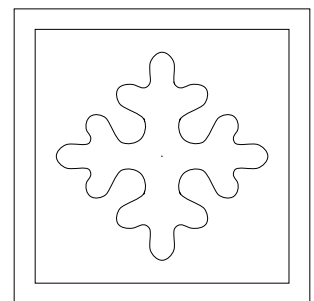

Snow Flake - Block - Large
Design Size - 11" x 11"
© R&S Designs

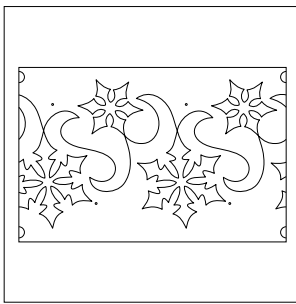

Snow Winds - Set
Set Size - 10" x 36"
© Barbara Becker

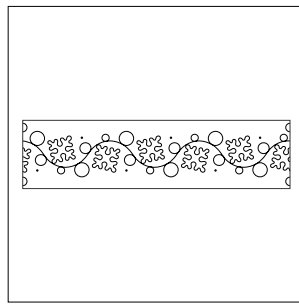

Snowdrift - 1 Row
Design Size - 4" x 23.5"
© Patricia E. Ritter

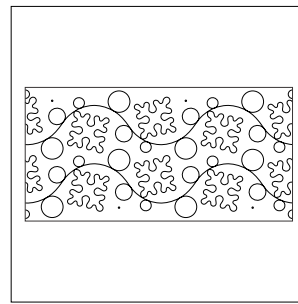

Snowdrift - 2 Row
Single Row Size - 6" x 23.5"
© Patricia E. Ritter

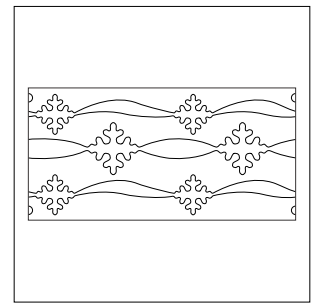

Snowflakes and Ribbons
Double Row Size - 7.25" x 23.75"
© R&S Designs

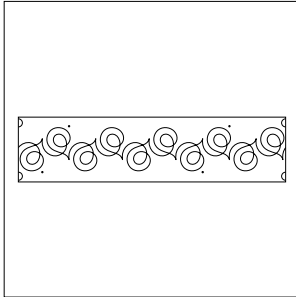

Soho #1
Design Size - 4" x 24.75"
© Sarah Ann Myers

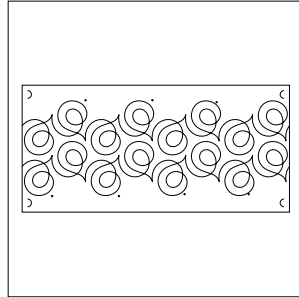

Soho #2
Single Row Size - 5" x 24.75"
© Sarah Ann Myers

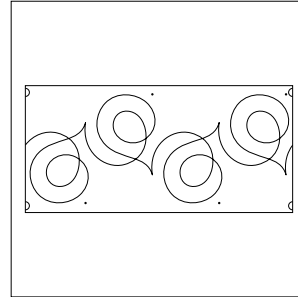

Soho #3
Design Size - 10" x 24.75"
© Sarah Ann Myers

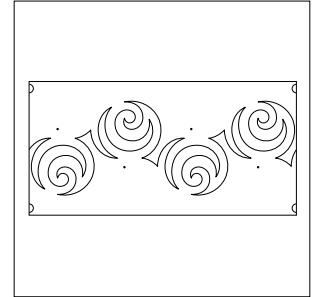

Solar Eclipse
Design Size - 8.25" x 23.5"
© Sarah Ann Myers

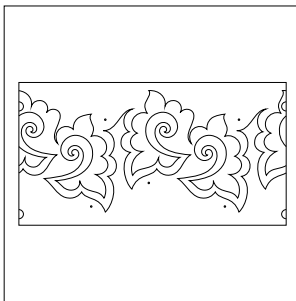

Somersault
Design Size - 10" x 22"
© Patricia E. Ritter & Valerie Smith

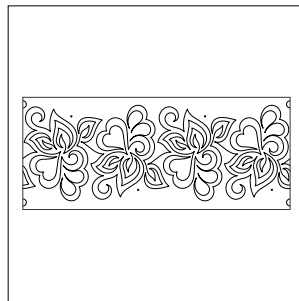

Sonnet
Design Size - 10" x 28"
© Patricia E. Ritter & Valerie Smith

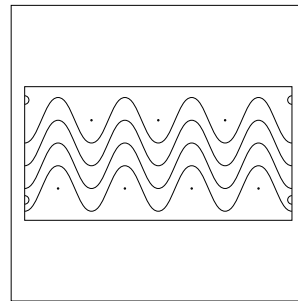

Sound Wave
Single Row Size - 4" x 23.5"
© Jessica Schick

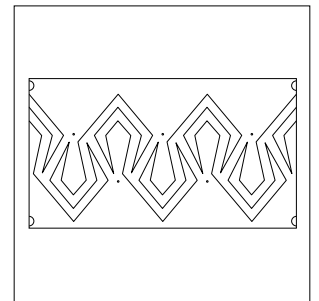

South Beach
Design Size - 10" x 21"
© Melonie J. Caldwell

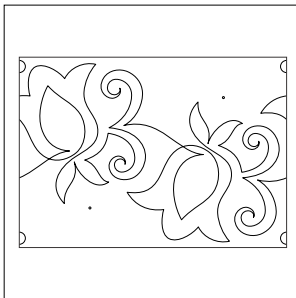

Southern Bell - Set
Set Size - 11" x 33"
© Sarah Ann Myers

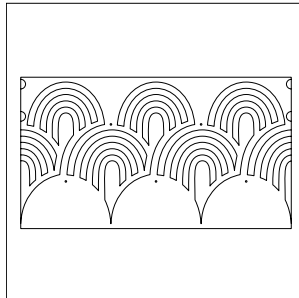

Spectrum
Design Size - 11" x 21"
© Patricia E. Ritter & Marybeth O'Halloran

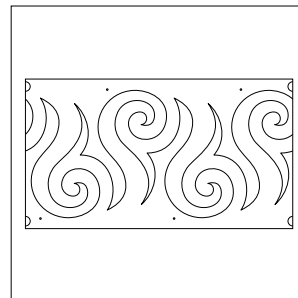

Spiked Swirl
Design Size - 10" x 21"
© Quilters Apothecary

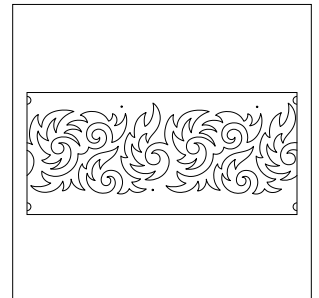

Spiky Spinners
Design Size - 8.75" x 26"
© Jessica Schick

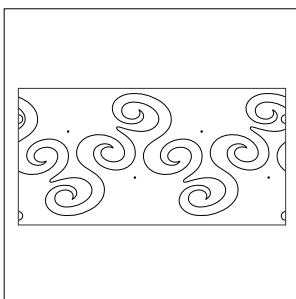

Spilled Ink
Design Size - 10.5" x 23"
© Sarah Ann Myers

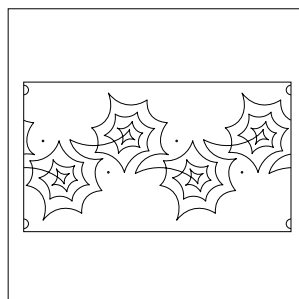

Spindle
Design Size - 10" x 21"
© Patricia E. Ritter & Melonie J. Caldwell

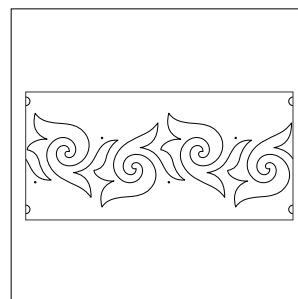

Spindrift
Design Size - 8.25" x 23.5"
© Sarah Ann Myers

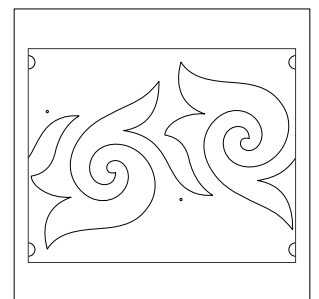

Spindrift - Grande - Set
Set Size - 10.5" x 30"
© Sarah Ann Myers

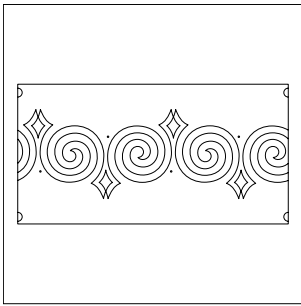

Spirals and Diamonds
Design Size - 7.5" x 22.75"
© Kalynda Grant

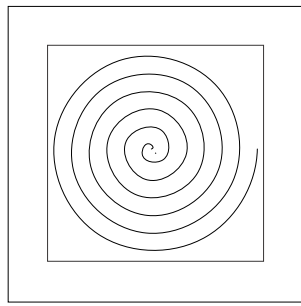

Spirals - Circle - Block - Small
Design Size - 6" x 6"
© R&S Designs

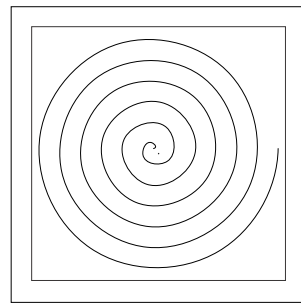

Spirals - Circle - Block - Large
Design Size - 11.25" x 10.75"
© R&S Designs

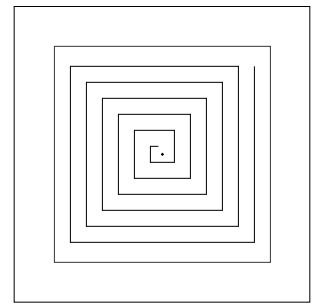

Spirals - Square - Block - Small
Design Size - 5.5" x 5.5"
© R&S Designs

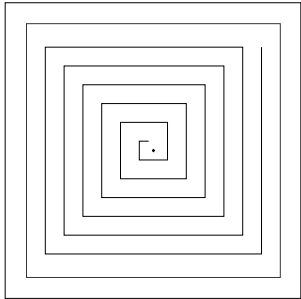

Spirals - Square - Block - Large
Design Size - 11.5" x 11.5"
© R&S Designs

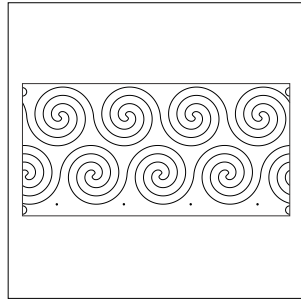

Spirals - Eight
Single Row Size - 5.25" x 23.75"
© R&S Designs

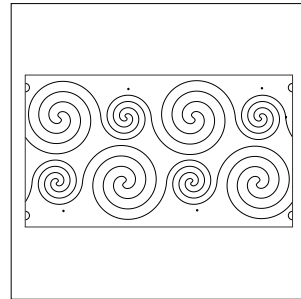

Spirals - Eight - Small and Large
Single Row Size - 6.5" x 23.75"
© R&S Designs

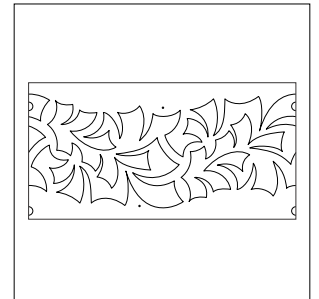

Splade
Design Size - 10" x 23.5"
© Hermione Agee

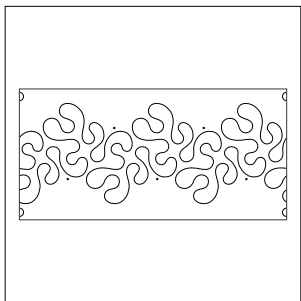

Splat
Design Size - 9" x 24"
© Barbara Becker

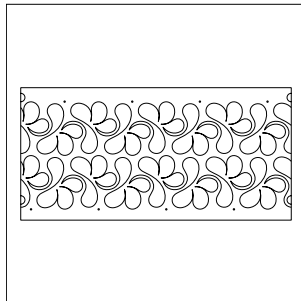

Splish Splash
Single Row Size - 4.75" x 24"
© Sarah Ann Myers

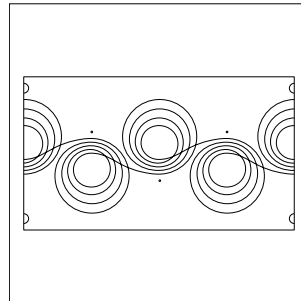

Spools of Thread
Design Size - 8.75" x 20.75"
© Patricia E. Ritter & Sarah Ann Myers

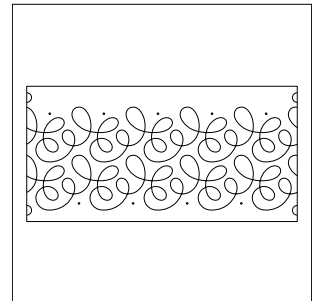

Spring Thing
Single Row Size - 4.25" x 21"
© Willow Leaf Designs

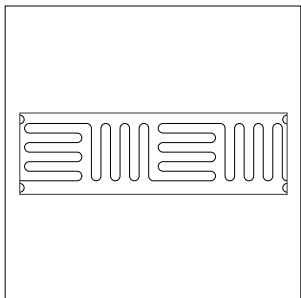

Square Fold - 1 Row
Design Size - 5" x 23"
© R&S Designs

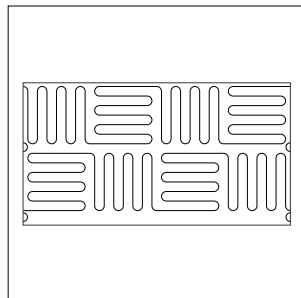

Square Fold - 2 Row
Single Row Size - 5" x 23"
© R&S Designs

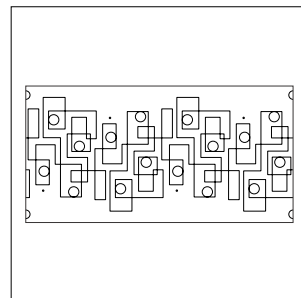

Square Peg Round Hole
Design Size - 10" x 23.5"
© Patricia E. Ritter & Tracey Russell

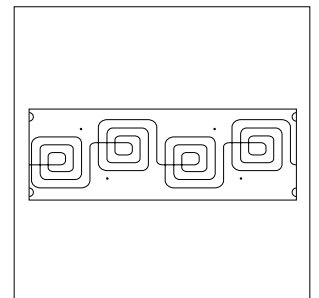

Square Root
Design Size - 6" x 23.5"
© Sarah Ann Myers

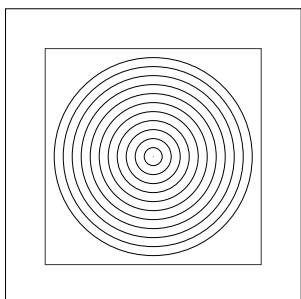

Stacked Circles - Block - Small
Circle Sizes - .5" to 5.5"
© R&S Designs

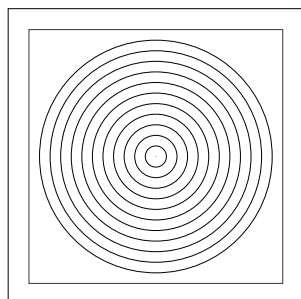

Stacked Circles - Block - Large
Circle Sizes - 1.5" to 12.5"
© R&S Designs

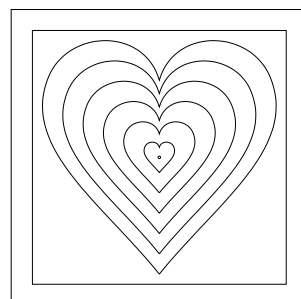

Stacked Heart - Block
Heart Sizes - 1.5" to 11.5"
© R&S Designs

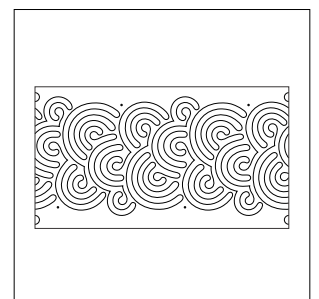

Stacked Snailz
Design Size - 10" x 21.5"
© Patricia E. Ritter & Marybeth O'Halloran

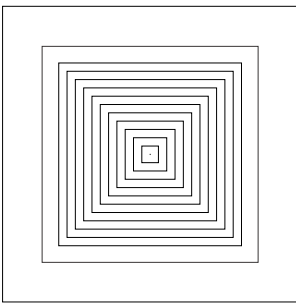

Stacked Square - Block - Small
Square Sizes - .5" to 5.5"

© R&S Designs

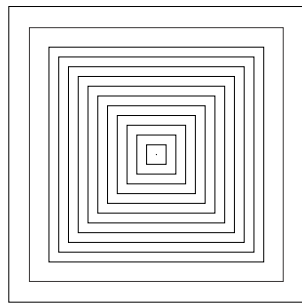

Stacked Square - Block - Large
Square Sizes - .5" x 10.5"

© R&S Designs

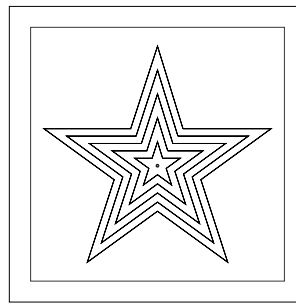

Stacked Star - Block
Star Sizes - 2" to 10.5"

© R&S Designs



Stacked Triangles - Block
Triangle Sizes - .7" x .8" to 9.5" x 11"

© R&S Designs

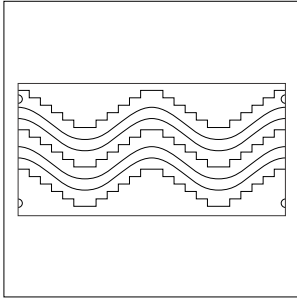

Staircase
Single Row Size - 5.5" x 23.75"

© R&S Designs

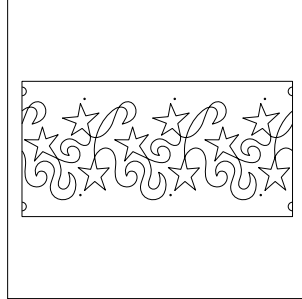

Star Dance
Design Size - 8.5" x 23.5"

© Barbara Becker

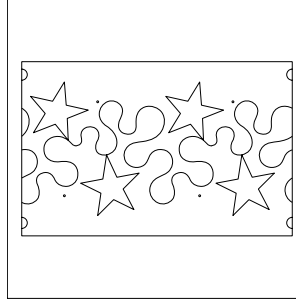

Star Shine
Design Size - 9" x 18.25"

© Apricot Moon Designs

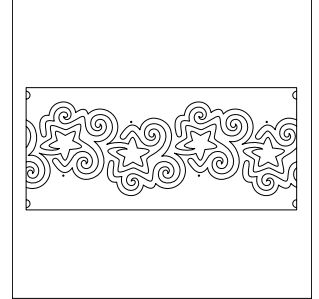

Stardust
Design Size - 9" x 26"

© Patricia E. Ritter

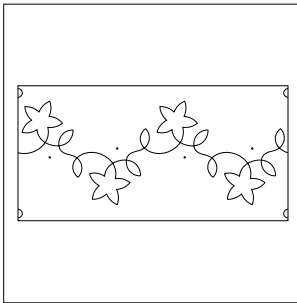

Starlight
Design Size - 9" x 23.5"

© Hermione Agee

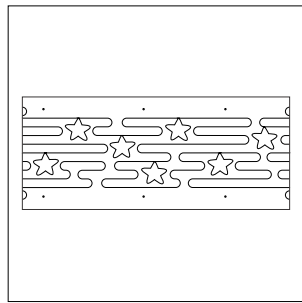

Stars and Bars
Design Size - 6.25" x 23.75"

© Patricia E. Ritter & Jessica Schick

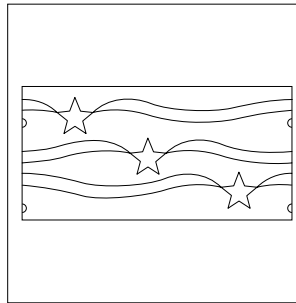

Stars and Stripes
Single Row Size - 3.25" x 23.75"

© R&S Designs

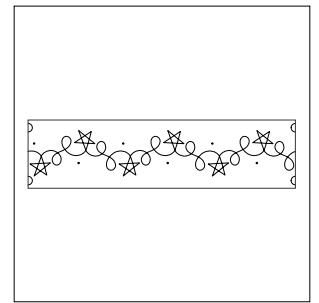

Starz - Petite
Design Size - 4" x 23.5"

© Patricia E. Ritter

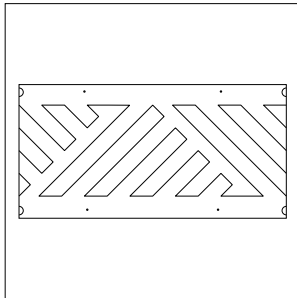

Steel Plate
Design Size - 8" x 23.5"

© Naomi Hynes

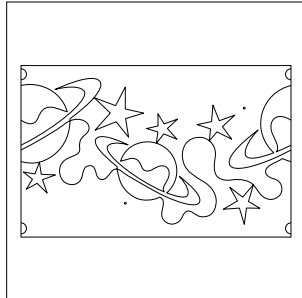

Stellar - Set
Set Size - 10" x 37"

© Naomi Hynes

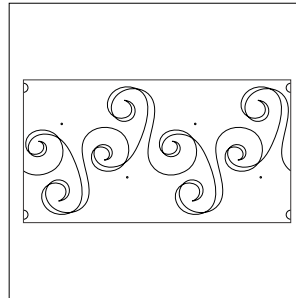

Streamer
Design Size - 10.5" x 22"

© Hermione Agee

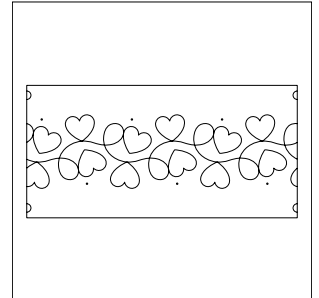

String of Hearts
Design Size - 6.5" x 24"

© Mel St. Clair

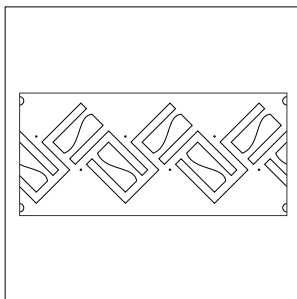

String Theory
Design Size - 9" x 24"

© Lisa H. Calle

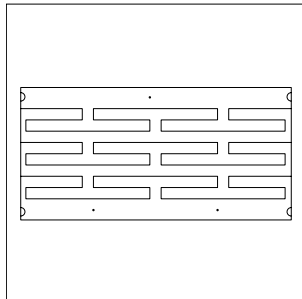

Subway Tiles
Single Row Size - 2" x 24"

© Melonie J. Caldwell

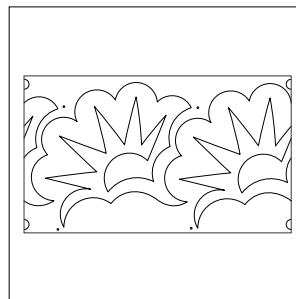

Sun Scallops
Design Size - 11" x 20"

© Hermione Agee

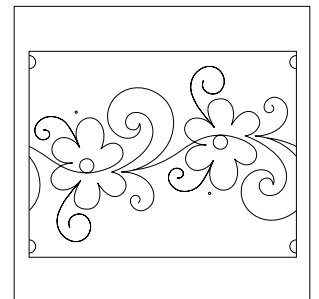

Sunshine - Set
Set Size - 10" x 30.5"

© Melonie J. Caldwell

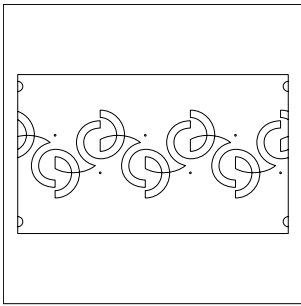

Supernova
Design Size - 6.5" x 20"
© Sarah Ann Myers

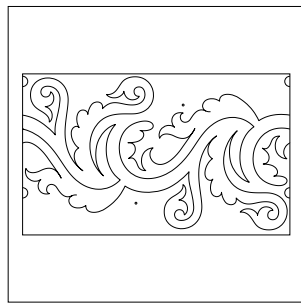

Swan Song
Design Size - 11.25" x 19.5"
© Patricia E. Ritter

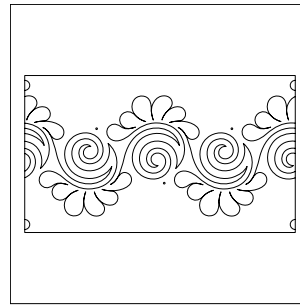

Swanky
Design Size - 9" x 20.25"
© Patricia E. Ritter & Sarah Ann Myers

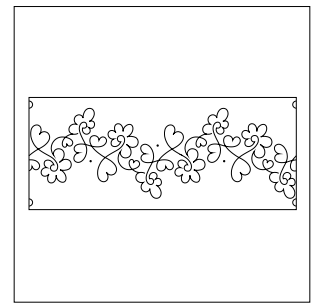

Sweet Hearts - Grande
Design Size - 9.5" x 28"
© Patricia E. Ritter

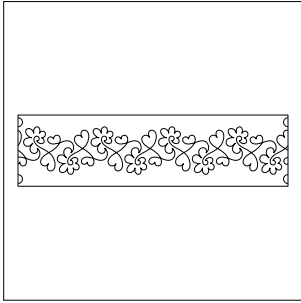

Sweet Hearts - Petite
Design Size - 4" x 22.75"
© Patricia E. Ritter

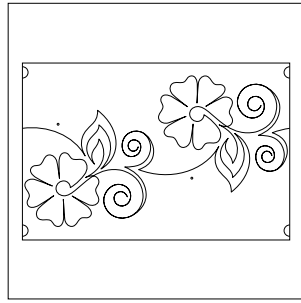

Sweet Indigo - Set
Set Size - 10" x 35.5"
© Patricia E. Ritter & Leisha Farnsworth

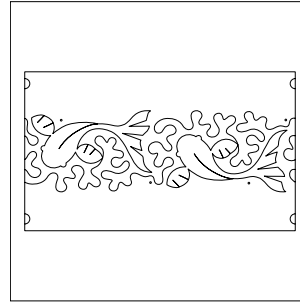

Swim - Border
Design Size - 6" x 20"
© Naomi Hynes

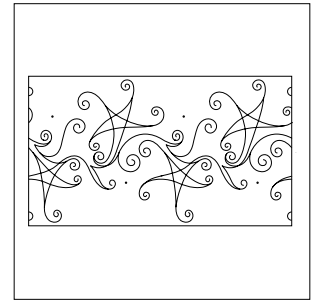

Swinging on a Star
Design Size - 12.75" x 23.75"
© Jessica Schick

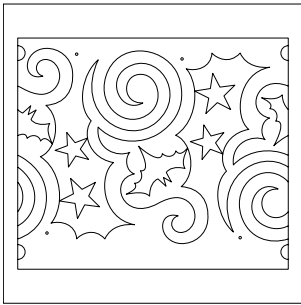

Swirly Bats - Set
Set Size - 10" x 27.5"
© Melissa Kelley

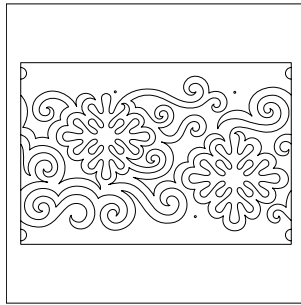

Swirly Snowflakes
Design Size - 10" x 17.5"
© Beany Girl Quilts

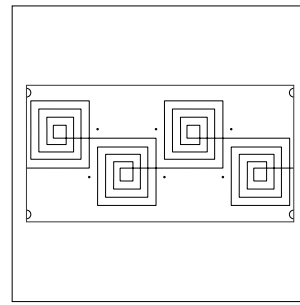

Symmetry
Design Size - 9" x 23"
© Patricia E. Ritter

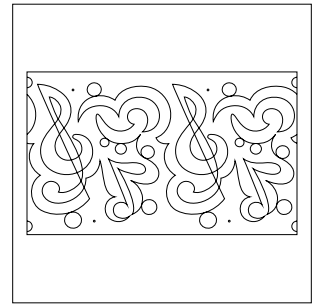

Symphony
Design Size - 10.5" x 19.5"
© Patricia E. Ritter

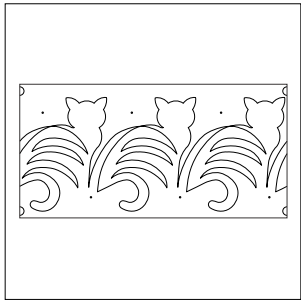

Tabbytales
Design Size - 10" x 22"
© Keryn Emmerson

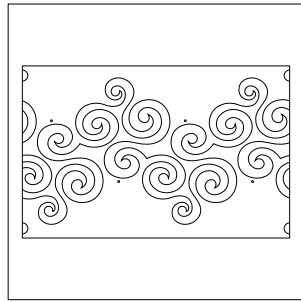

Taffeta - Set
Set Size - 10" x 36.5"
© Patricia E. Ritter

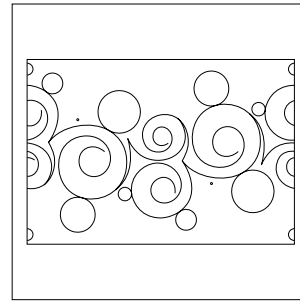

Tahitian Pearl - Set
Set Size - 10.25" x 34"
© Patricia E. Ritter & Leisha Farnsworth

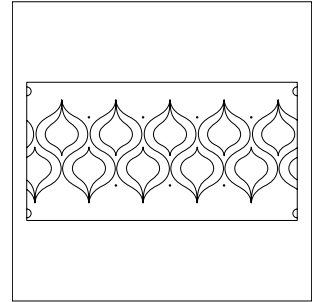

Taj Mahal - Echoed
Design Size - 8.75" x 23"
© Patricia E. Ritter & Leisha Farnsworth

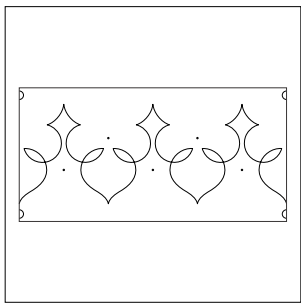

Taka
Design Size - 8.75" x 23.5"
© Keryn Emmerson

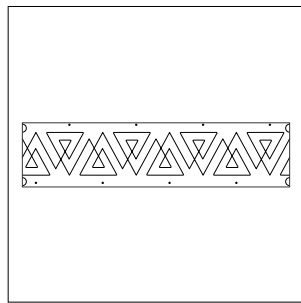

Take Five - Petite - 1 Row
Design Size - 4" x 25"
© Patricia E. Ritter

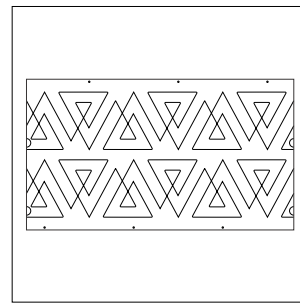

Take Five - Petite - 2 Row
Single Row Size - 5" x 23.5"
© Patricia E. Ritter

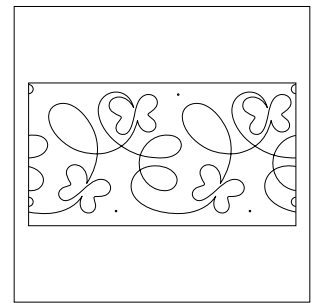

Take Flight - Butterfly
Design Size - 10" x 22"
© Patricia E. Ritter

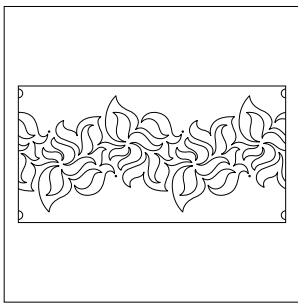

Tandoori
Design Size - 10" x 23"
© Patricia E. Ritter

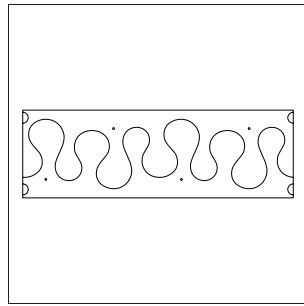

Tangle - Unfurled
Design Size - 4.75" x 18.5"
© Patricia E. Ritter

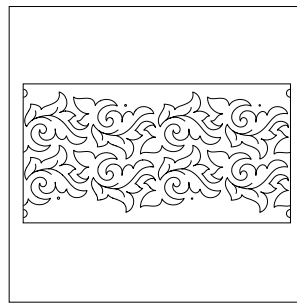

Taro
Single Row Size - 6.25" x 25"
© Patricia E. Ritter

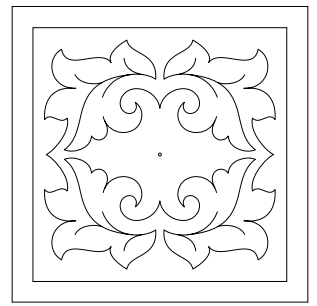

Taro - Block
Design Size - 10" x 10"
© Patricia E. Ritter

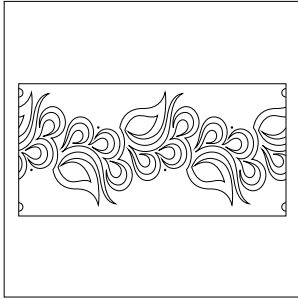

Tea Lights
Design Size - 10" x 23.75"
© Patricia E. Ritter & Valerie Smith

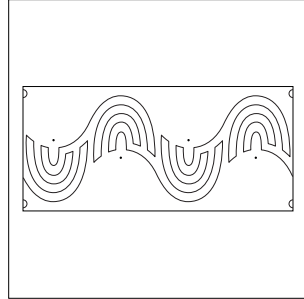

Teeter Totter
Design Size - 10" x 25.5"
© Patricia E. Ritter & Sarah Ann Myers

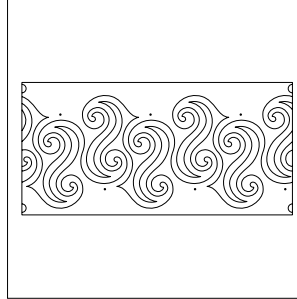

The Tempest
Design Size - 10" x 24"
© Naomi Hynes

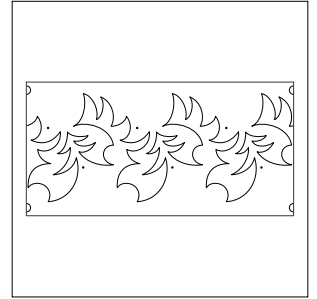

Thicket
Design Size - 9.5" x 23.5"
© Hermione Agee

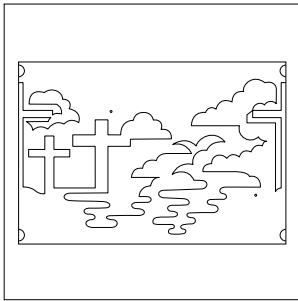

Three Crosses - Set
Set Size - 10" x 34.5"
© Dave Hudson

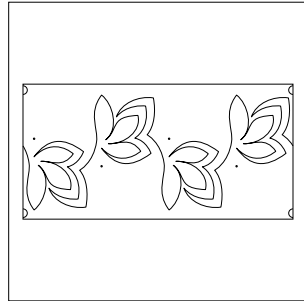

Thyme
Design Size - 10" x 23.5"
© Patricia E. Ritter & Denise Schillinger

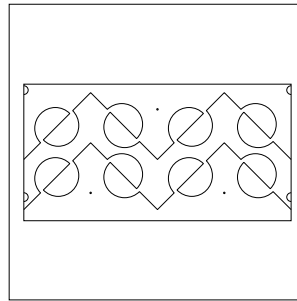

Tic Tac Toe
Single Row Size - 5.75" x 23"
© Andi Rudebusch

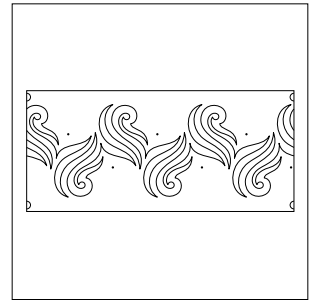

Tigris
Design Size - 9" x 26"
© Hermione Agee

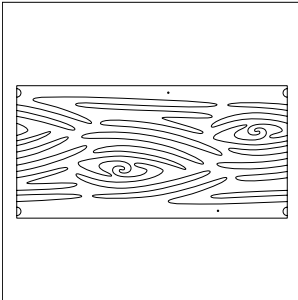

Timber
Design Size - 9.5" x 24"
© Melonie J. Caldwell

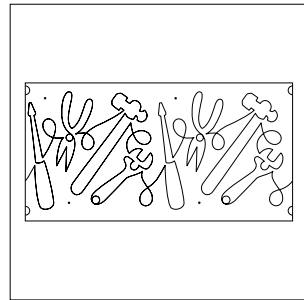

Tool Time
Design Size - 10" x 22.75"
© Patricia E. Ritter

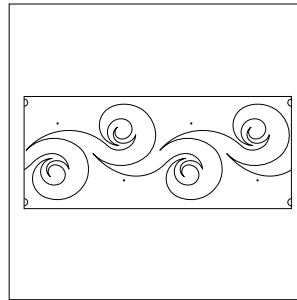

Torrent
Design Size - 10" x 28"
© Hermione Agee

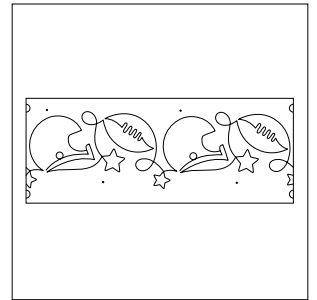

Touchdown
Design Size - 7.25" x 25.5"
© Patricia E. Ritter

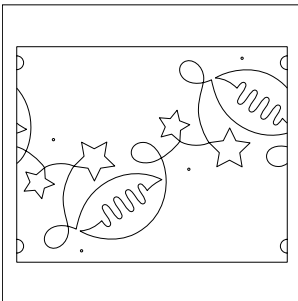

Touchdown Football - Set
Set Size - 10.25" x 29.5"
© Patricia E. Ritter & Melonie J. Caldwell

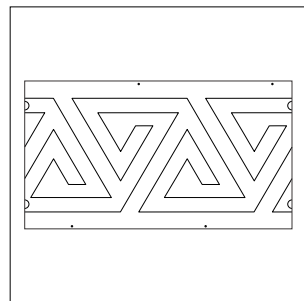

Trapeze
Design Size - 10" x 23.5"
© Patricia E. Ritter & Leisha Farnsworth

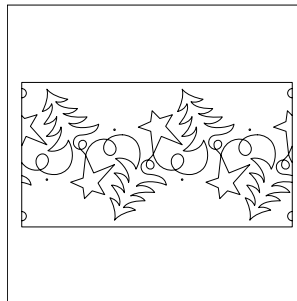

Treelight
Design Size - 10.75" x 22"
© Lakeridge Designs / Kimberly Dewling

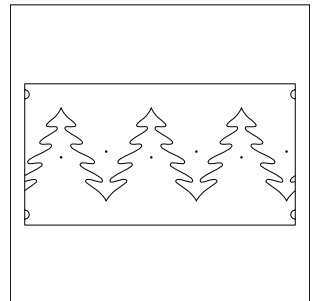

Treetop
Design Size - 7.75" x 22.5"
© Willow Leaf Designs

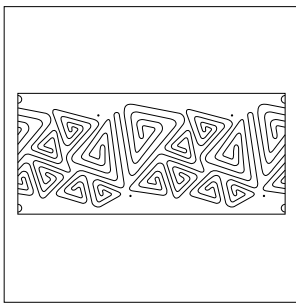

Triangle Maze
Design Size - 10" x 26"
© Janet-Lee Santeusanio

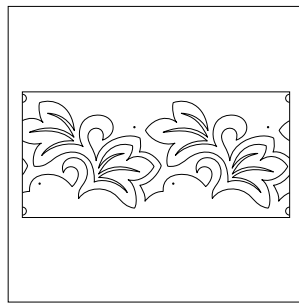

Tropical
Design Size - 10" x 25"
© Naomi Hynes

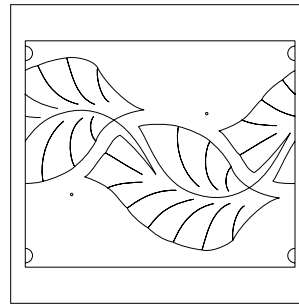

Tropical Deco - Set
Set Size - 10" x 28"
© Patricia E. Ritter

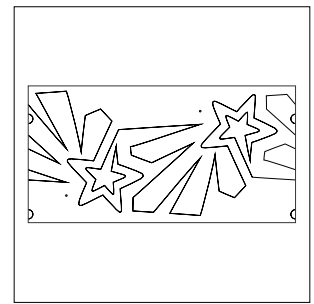

True Blue - Grande
Design Size - 10" x 21.5"
© Patricia E. Ritter

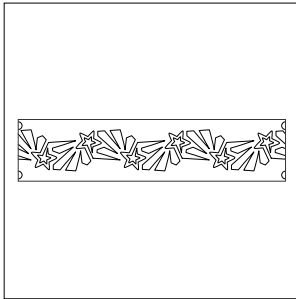

True Blue - Petite - 1 Row
Design Size - 4" x 26"
© Patricia E. Ritter

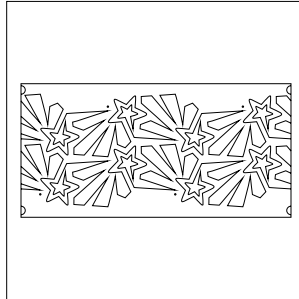

True Blue - Petite - 2 Row
Single Row Size - 5.5" x 23.75"
© Patricia E. Ritter

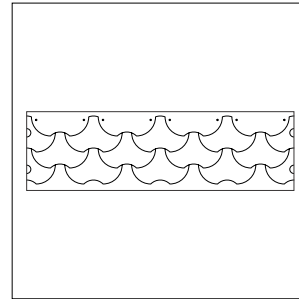

Trumpet Flower
Single Row Size - 3.25" x 23.75"
© R&S Designs

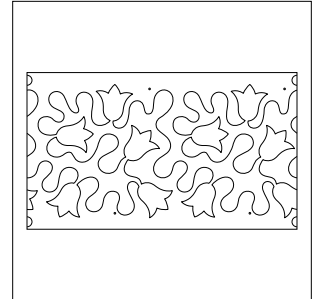

Tulip Trail Stipple
Design Size - 10" x 20.25"
© Laura Estes

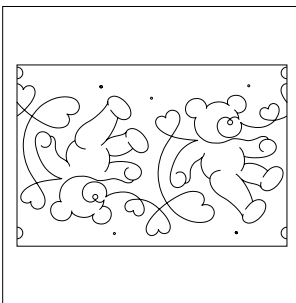

Tumblin' Teddy Bear - Set
Set Size - 10" x 35"
© Patricia E. Ritter

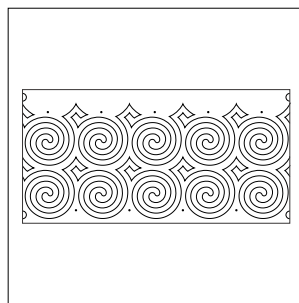

Turbulence
Single Row Size - 6" x 26"
© Lisa H. Calle

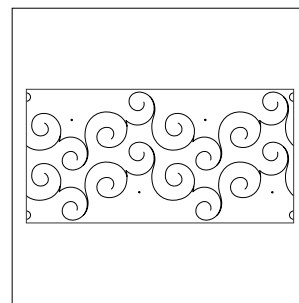

Twine
Single Row Size - 7" x 24"
© Hermione Agee

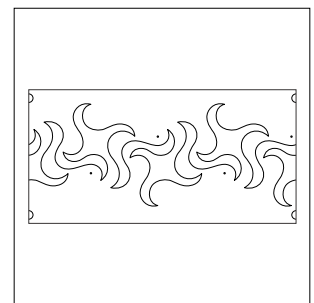

Twister
Design Size - 9" x 23.5"
© Megan Hahn

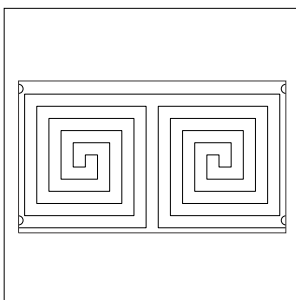

Two Squares - In and Out
Design Size - 11" x 22"
© R&S Designs

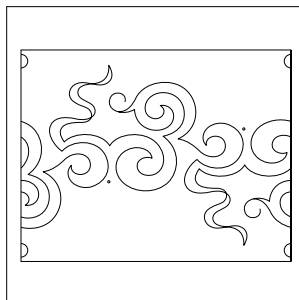

Under the Sea - Set
Set Size - 10" x 30"
© Hermione Agee

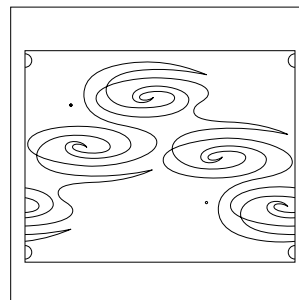

Undertow - Set
Set Size - 10" x 30"
© Patricia E. Ritter & Janet-Lee Santeusanio

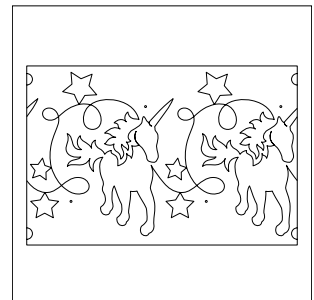

Unicorns and Glitter
Design Size - 10.75" x 17.75"
© Patricia E. Ritter & OESD

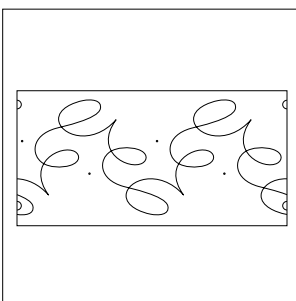

Unwind
Design Size - 10" x 23.5"
© Megan Hahn

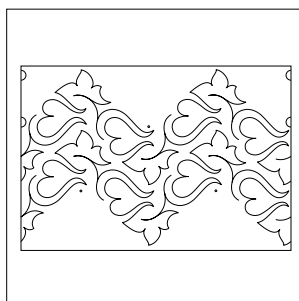

Valentine
Single Row Size - 8.75" x 20.5"
© Patricia E. Ritter

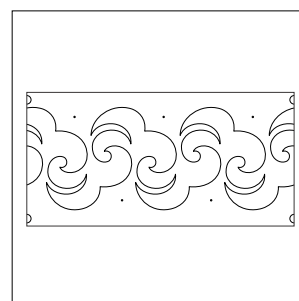

Vapour
Design Size - 9" x 23.5"
© Hermione Agee

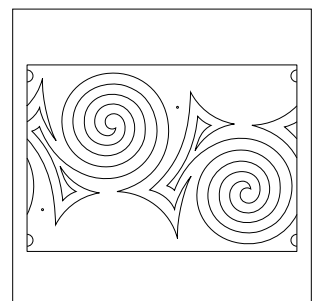

Vertigo - Set
Set Size - 10.75" x 34"
© Patricia E. Ritter & Marybeth O'Halloran

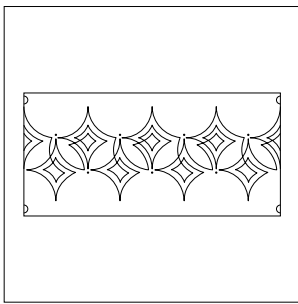

Verve
Design Size - 9" x 24.5"
© Patricia E. Ritter

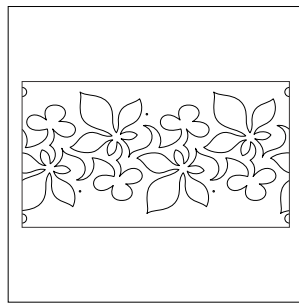

Vigour
Design Size - 10" x 22"
© Hermione Agee

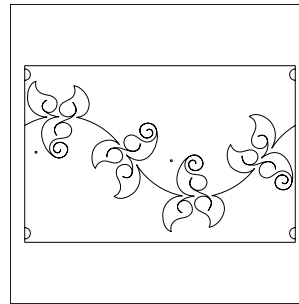

Vine #2
Design Size - 10" x 18"
© Patricia E. Ritter & Jamie Wallen / Quilters Apothecary

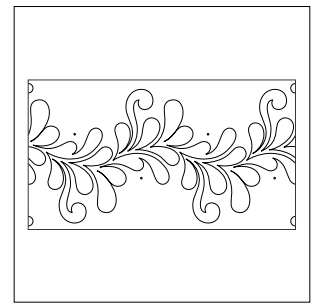

Viola
Design Size - 10.5" x 21"
© Patricia E. Ritter & Leisha Farnsworth

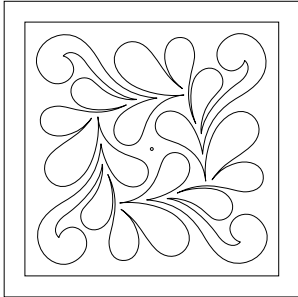

Viola - Block
Design Size - 10" x 10"
© Patricia E. Ritter & Leisha Farnsworth

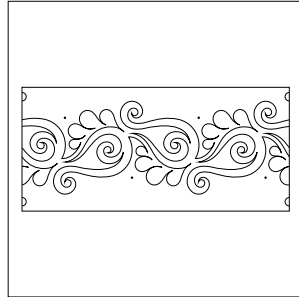

Vogue
Design Size - 8.25" x 23.75"
© Patricia E. Ritter & Valerie Smith

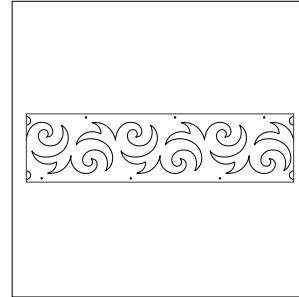

Voltage - Border
Design Size - 4.5" x 23.5"
© Patricia E. Ritter

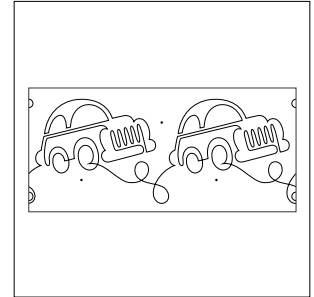

Vroom Vroom
Design Size - 9.25" x 23.75"
© Patricia E. Ritter

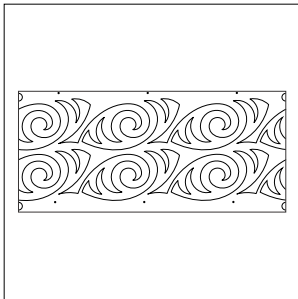

Waitomo
Single Row Size - 5" x 26"
© Hermione Agee

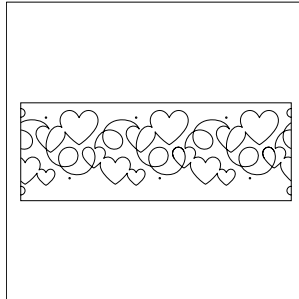

Waltzing Hearts
Design Size - 6.5" x 23.5"
© Mel St. Clair

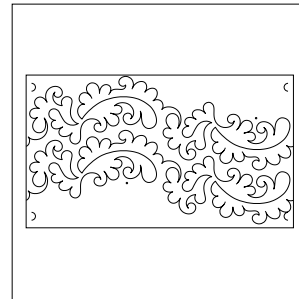

Wandering Feathers
Single Row Size - 8.5" x 24.5"
© Patricia E. Ritter

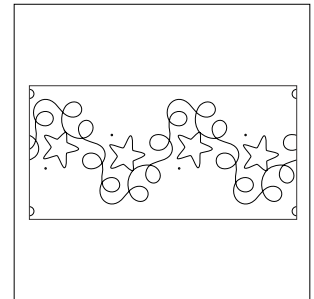

Wandering Star
Design Size - 8.5" x 24.5"
© Patricia E. Ritter

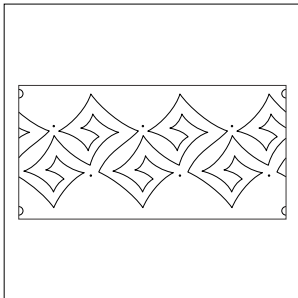

Wasabi
Design Size - 10" x 23.5"
© Patricia E. Ritter

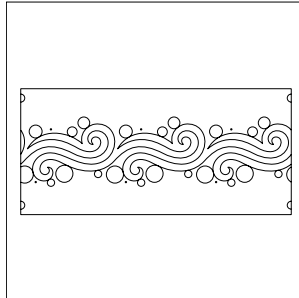

Water Waves
Design Size - 6.5" x 25.25"
© Melissa Kelley

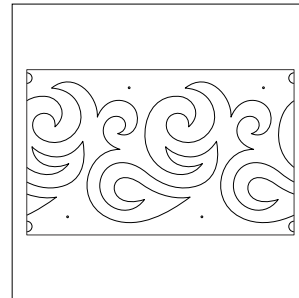

Water Wings
Design Size - 10" x 19"
© Barbara Becker

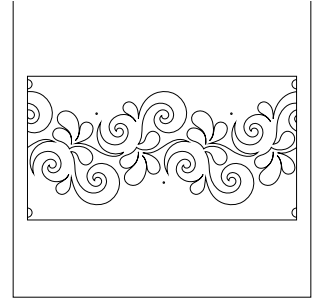

Wave on Wave
Design Size - 9.25" x 22"
© Patricia E. Ritter

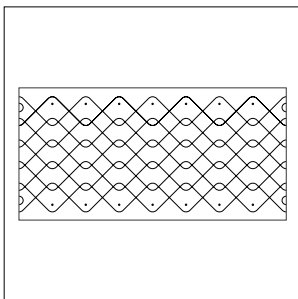

Wavy
Single Row Size - 2.5" x 23.75"
© R&S Designs

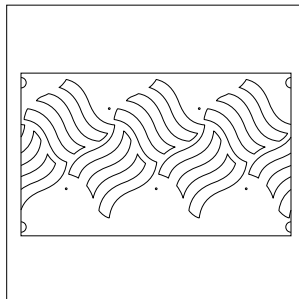

Wavy Gravy
Design Size - 10" x 19.5"
© Patricia E. Ritter

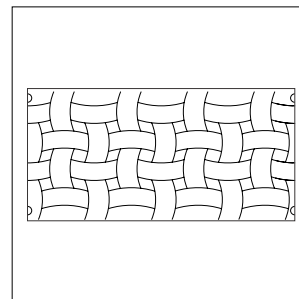

Weave
Design Size - 11.5" x 23.75"
© R&S Designs

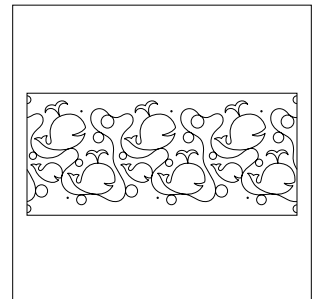

Whales Everywhere
Design Size - 10" x 26"
© Dave Hudson

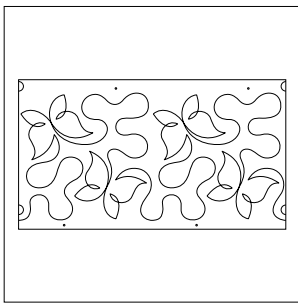

Whim
Design Size - 10" x 21"
© Jessica Schick

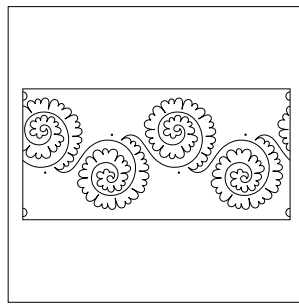

Whirligig
Design Size - 10" x 24"
© Sarah Ann Myers

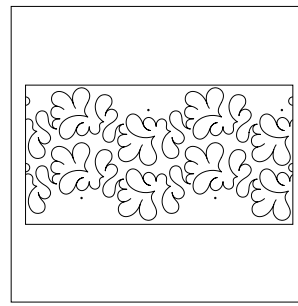

Whirlwind
Single Row Size - 7" x 24"
© Patricia E. Ritter

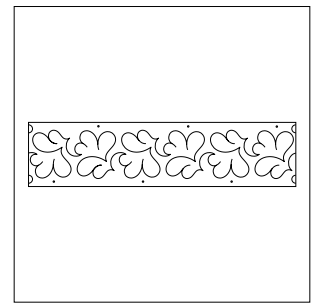

Whirlwind - Petite
Design Size - 4.5" x 25"
© Patricia E. Ritter

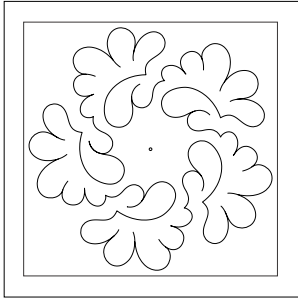

Whirlwind - Block
Design Size - 11.25" x 11.25"
© Patricia E. Ritter

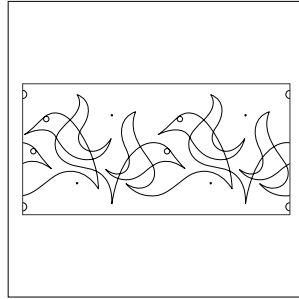

Whirlybird
Design Size - 10" x 24.5"
© Patricia E. Ritter & Megan Hahn

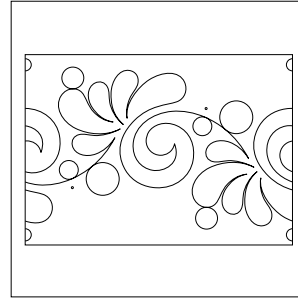

Whisper - Set
Set Size - 10" x 33"
© Melonie J. Caldwell

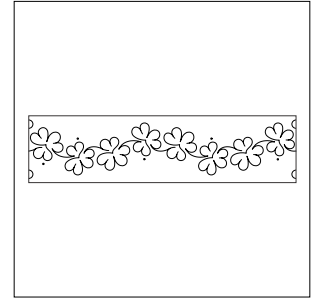

White Clover - Petite
Design Size - 4.75" x 24"
© Patricia E. Ritter

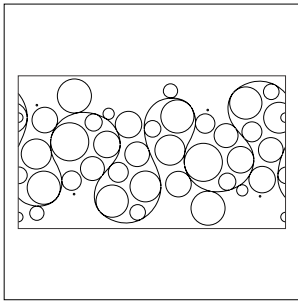

Whole Lotta Bubbles
Design Size - 11.5" x 21"
© Patricia E. Ritter

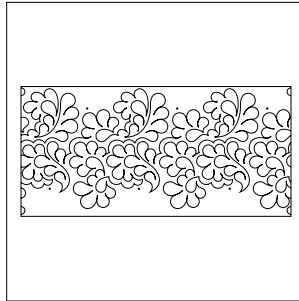

Whole Lotta Feathers
Design Size - 11.5" x 26"
© Patricia E. Ritter

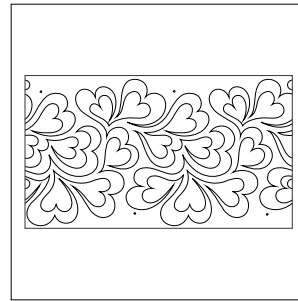

Whole Lotta Love
Design Size - 11.5" x 21"
© Patricia E. Ritter

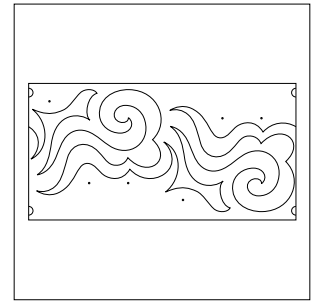

Whoosh
Design Size - 10.5" x 23"
© Hermione Agee

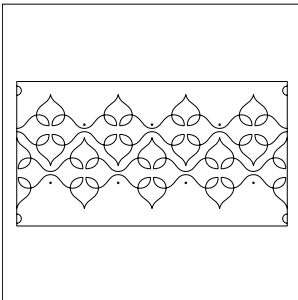

Willow Leaf's Starlight
Single Row Size - 2.75" x 22"
© Willow Leaf Designs

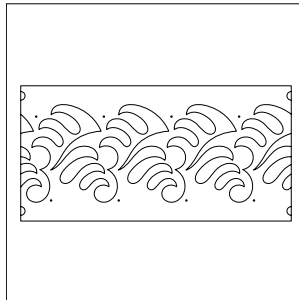

Willow Leaf's Tsunami
Design Size - 8.5" x 23.5"
© Willow Leaf Designs

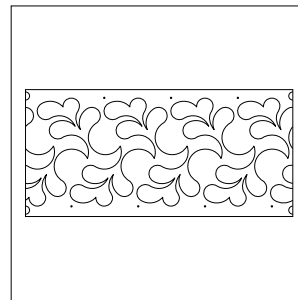

Wind Plume
Design Size - 10" x 24.75"
© Keryn Emmerson

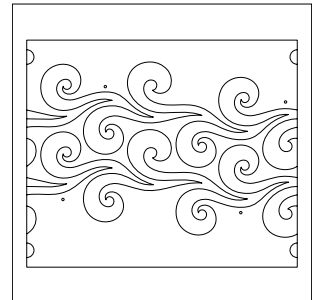

Wind Water - Set
Set Size - 5.5" x 28"
© Kathie James

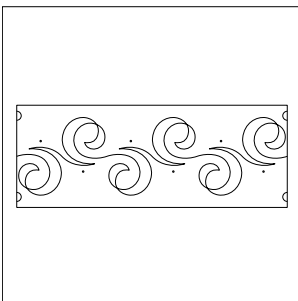

Windswept
Design Size - 6.5" x 22.5"
© Naomi Hynes

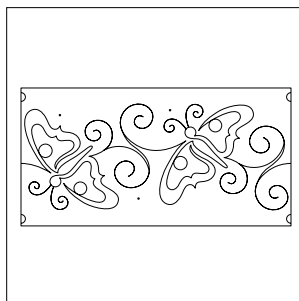

Wing and Wind
Design Size - 9" x 23"
© Patricia E. Ritter

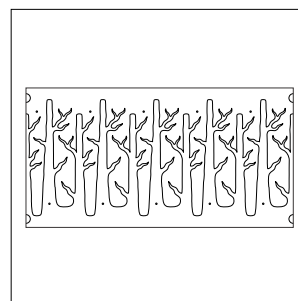

Winter Forest
Design Size - 10" x 23"
© Melonie J. Caldwell

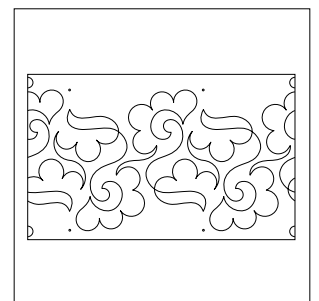

Winter Garden - Set
Set Size - 10" x 38"
© Naomi Hynes

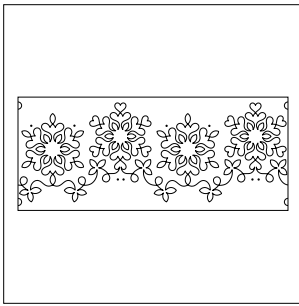

Winter Wonderland
Design Size - 10.25" x 28"
© Patricia E. Ritter

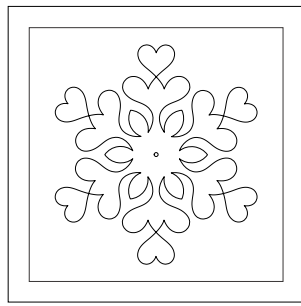

Winter Wonderland - Block #1
Design Size - 6.5" x 7"
© Patricia E. Ritter

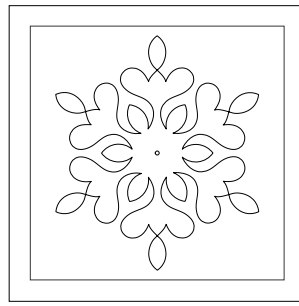

Winter Wonderland - Block #2
Design Size - 6.5" x 7.5"
© Patricia E. Ritter

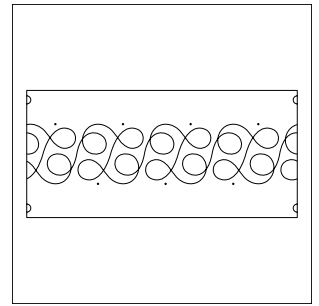

Wire Wrap
Design Size - 5.5" x 25"
© Jessica Schick

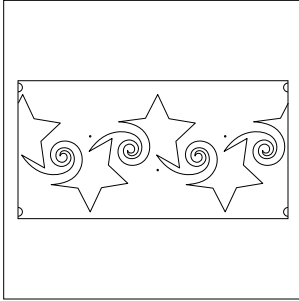

Wishing On a Star
Design Size - 10" x 23"
© Patricia E. Ritter

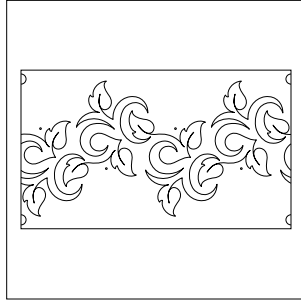

Wisteria
Design Size - 10" x 20"
© Patricia E. Ritter

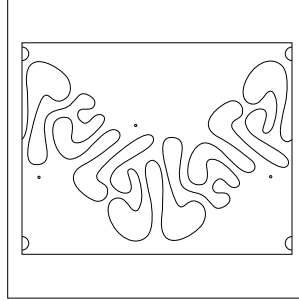

Wobbly - Set
Set Size - 10" x 30"
© Naomi Hynes

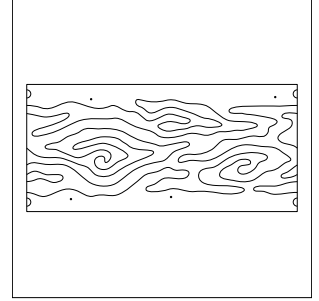

Wood Grain
Design Size - 9" x 25"
© Jessica Schick

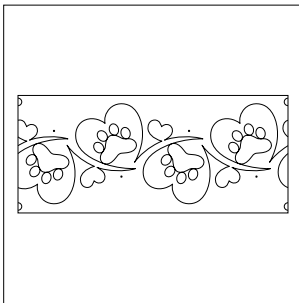

Woof
Design Size - 10" x 27"
© Melonie J. Caldwell

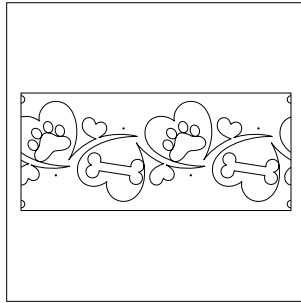

Woof - Dog Treats
Design Size - 10" x 27"
© Melonie J. Caldwell

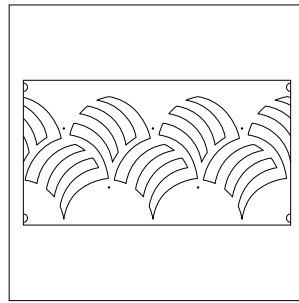

Woven Wind
Design Size - 11" x 24"
© Apricot Moon Designs

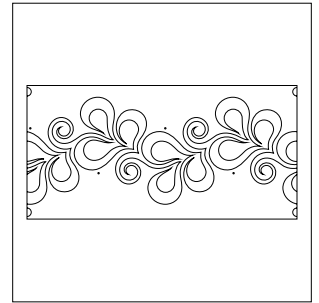

Xanadu
Design Size - 9.5" x 23.75"
© Patricia E. Ritter

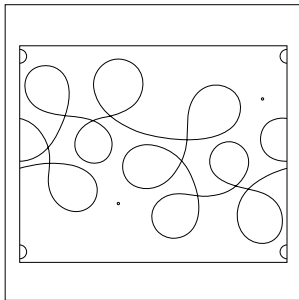

Yarn Tangle - Set
Set Size - 10" x 29"
© Apricot Moon Designs

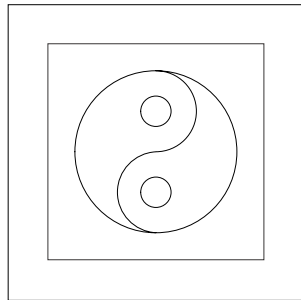

Yin Yang - Block - Small
Design Size - 6" x 6"
© R&S Designs

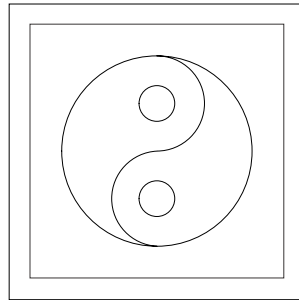

Yin Yang - Block - Large
Design Size - 8" x 8"
© R&S Designs

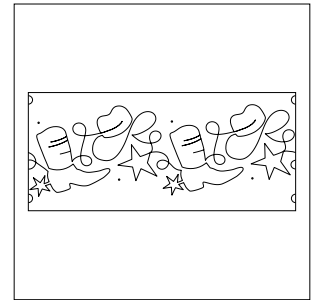

Yippee Ki Yay
Design Size - 8.25" x 23.75"
© Patricia E. Ritter

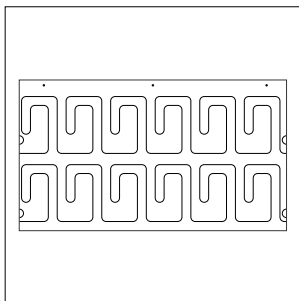

Yodel Echo
Single Row Size - 5" x 23.5"
© Laura Estes

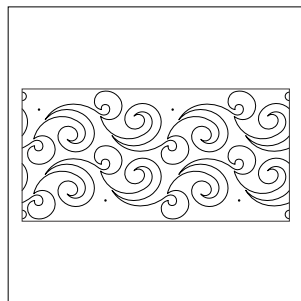

Zephyr
Single Row Size - 6.5" x 23.75"
© Hermione Agee

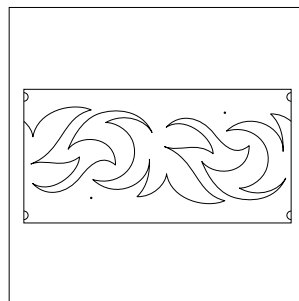

Zest
Design Size - 8.5" x 23.5"
© Patricia E. Ritter

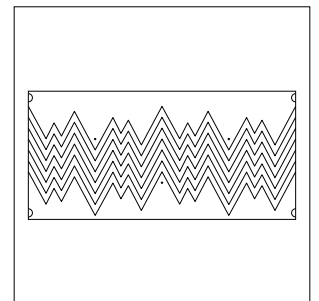

Zigzagz
Single Row Size - 4" x 24.5"
© Patricia E. Ritter

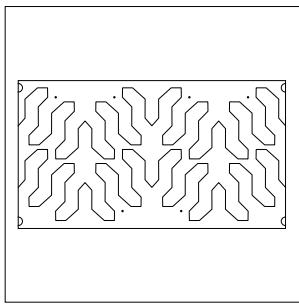

Zipline
Single Row Size - 6.25" x 23.5"
© Judy Borger

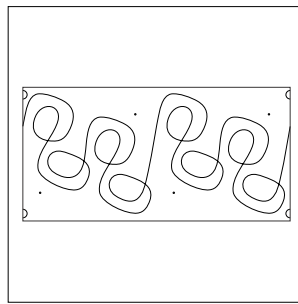

Zydeco
Design Size - 10.5" x 23.5"
© Sarah Ann Myers

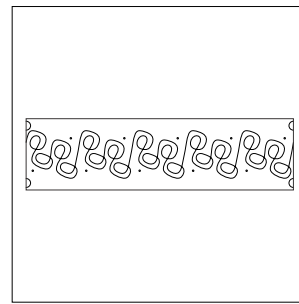

Zydeco - Petite
Design Size - 4" x 22.5"
© Sarah Ann Myers

© All rights reserved.
Copyright and designer info available upon request.



Visit our website at:

www.urbanelementz.com
www.appliqueelementz.com

To see our entire selection of:

Pantographs
Tear Away
Stencils
Design Boards
Appliqué Elementz
Tattoo Elementz - Decorative Decals
Patterns and Books
Quilting Accessories



1308 common street
suite 205 . box 50
new braunfels . texas . 78130
830 . 964 . 6133